



**COMMONWEALTH OF PENNSYLVANIA  
DEPARTMENT OF ENVIRONMENTAL PROTECTION  
AIR QUALITY PROGRAM**

**STATE ONLY OPERATING PERMIT**

Issue Date: October 10, 2019

Effective Date: January 1, 2020

Expiration Date: December 31, 2024

In accordance with the provisions of the Air Pollution Control Act, the Act of January 8, 1960, P.L. 2119, as amended, and 25 Pa. Code Chapter 127, the Owner, [and Operator if noted] (hereinafter referred to as permittee) identified below is authorized by the Department of Environmental Protection (Department) to operate the air emission source(s) more fully described in this permit. This Facility is subject to all terms and conditions specified in this permit. Nothing in this permit relieves the permittee from its obligations to comply with all applicable Federal, State and Local laws and regulations.

The regulatory or statutory authority for each permit condition is set forth in brackets. All terms and conditions in this permit are federally enforceable unless otherwise designated.

**State Only Permit No: 54-00019**

Synthetic Minor

Federal Tax Id - Plant Code: 47-5425417-1

**Owner Information**

Name: VERSUM MATERIALS US LLC

Mailing Address: 357 MARIAN AVE

TAMAQUA, PA 18252-4762

**Plant Information**

Plant: VERSUM MATERIALS US LLC/RUSH TWP

Location: 54 Schuylkill County

54954 Rush Township

SIC Code: 2813 Manufacturing - Industrial Gases

**Responsible Official**

Name: KARL NOLTE

Title: DIR OF OPR

Phone: (570) 467 - 2981

**Permit Contact Person**

Name: MATTHEW SULLIVAN

Title: ENVIRONMENTAL SPECIALIST

Phone: (570) 467 - 4142

[Signature] \_\_\_\_\_

MARK J. WEJKSZNER, NORTHEAST REGION AIR PROGRAM MANAGER



## SECTION A. Table of Contents

### Section A. Facility/Source Identification

Table of Contents  
Site Inventory List

### Section B. General State Only Requirements

- #001 Definitions.
- #002 Operating Permit Duration.
- #003 Permit Renewal.
- #004 Operating Permit Fees under Subchapter I.
- #005 Transfer of Operating Permits.
- #006 Inspection and Entry.
- #007 Compliance Requirements.
- #008 Need to Halt or Reduce Activity Not a Defense.
- #009 Duty to Provide Information.
- #010 Revising an Operating Permit for Cause.
- #011 Operating Permit Modifications
- #012 Severability Clause.
- #013 De Minimis Emission Increases.
- #014 Operational Flexibility.
- #015 Reactivation
- #016 Health Risk-based Emission Standards and Operating Practice Requirements.
- #017 Circumvention.
- #018 Reporting Requirements.
- #019 Sampling, Testing and Monitoring Procedures.
- #020 Recordkeeping.
- #021 Property Rights.
- #022 Alternative Operating Scenarios.

### Section C. Site Level State Only Requirements

- C-I: Restrictions
- C-II: Testing Requirements
- C-III: Monitoring Requirements
- C-IV: Recordkeeping Requirements
- C-V: Reporting Requirements
- C-VI: Work Practice Standards
- C-VII: Additional Requirements
- C-VIII: Compliance Certification
- C-IX: Compliance Schedule

### Section D. Source Level State Only Requirements

- D-I: Restrictions
- D-II: Testing Requirements
- D-III: Monitoring Requirements
- D-IV: Recordkeeping Requirements
- D-V: Reporting Requirements
- D-VI: Work Practice Standards
- D-VII: Additional Requirements

Note: These same sub-sections are repeated for each source!

### Section E. Source Group Restrictions

- E-I: Restrictions
- E-II: Testing Requirements
- E-III: Monitoring Requirements



## SECTION A. Table of Contents

- E-IV: Recordkeeping Requirements
- E-V: Reporting Requirements
- E-VI: Work Practice Standards
- E-VII: Additional Requirements

## Section F. Alternative Operating Scenario(s)

- F-I: Restrictions
- F-II: Testing Requirements
- F-III: Monitoring Requirements
- F-IV: Recordkeeping Requirements
- F-V: Reporting Requirements
- F-VI: Work Practice Standards
- F-VII: Additional Requirements

## Section G. Emission Restriction Summary

## Section H. Miscellaneous

**SECTION A. Site Inventory List**

Source ID	Source Name	Capacity/Throughput	Fuel/Material
031	WEST 2 BOILER 1	14.700 MMBTU/HR	
032	WEST 2 BOILER 2	14.700 MMBTU/HR	
103	FLUORINE CHEM OPERATIONS		
105	RESIDUAL GAS TREATMENT OPERATION		
106B	TOUCH-UP PAINT BOOTHS		
107	F2 COLD DEGREASER		
111	NF3 WEST OPERATIONS		
115	FLOURINE WEST II PROCESS		
116	NF3 WEST II PRODUCTION TRAINS 110 AND 120		
117	NF3 WEST II PRODUCTION TRAINS 130 AND 140		
118	NF3 WEST II PRODUCTION TRAINS 150 AND 160		
119	NF3 WEST II PRODUCTION TRAINS 170 AND 180		
ENG1	EMERGENCY FIRE PUMP ENGINE 1		
ENG2	EMERGENCY GENERATOR 1		
ENG3	EMERGENCY GENERATOR 2		
ENG4	EMERGENCY GENERATOR 3		
C010A	NF3 WEST II SCRUBBER 810		
C010B	NF3 WEST II SCRUBBER 820		
C010C	NF3 WEST II SCRUBBER 830		
C010D	NF3 WEST II SCRUBBER 840		
C016P	FIVE (5) F2 SCRUBBERS		
C017P	ONE (1) #6 F2 SCRUBBER		
C061P	RGT CYL EVAC/VENT BOOTH (2) SCRUBBERS		
C068P	PACKAGED AIR COOLED WATER CHILLER		
C082P	FIVE (5) ABATEMENT SCRUBBERS		
C08PB	DRY FILTERS		
C09	(5) FLOURINE WEST II SCRUBBERS		
FML01	WEST 2 FUEL OIL TANK		
FML02	DIESEL FUEL		
S031	STACK - SOURCE ID 031		
S032	STACK - SOURCE ID 032		
S03A	F2 TOWER 1 STACK		
S03B	F2 TOWER 2 STACK		
S03C	F2 TOWER 3 STACK		
S03D	F2 TOWER 4 STACK		
S03E	F2 TOWER 5 STACK		
S03F	F2 TOWER #6 STACK		
S05C	VENT BOOTH SCRUBBER STACK		
S05D	CYL EVAC SCRUBBER STACK		
S06B	TOUCH-UP PAINT BOOTH EXHAUSTS		

**SECTION A. Site Inventory List**

Source ID	Source Name	Capacity/Throughput	Fuel/Material
S12A	NF3 WEST SCRUBBER 1 STACK		
S12B	NF3 WEST SCRUBBER 2 STACK		
S12C	NF3 WEST SCRUBBER 3 STACK		
S12D	NF3 WEST SCRUBBER 4 STACK		
S12E	NF3 WEST SCRUBBER 5 STACK		
S13A	NF3 WEST II SCRUBBER #810 STACK		
S13B	NF3 WEST II SCRUBBER #820 STACK		
S13C	NF3 WEST II SCRUBBER #830 STACK		
S13D	NF3 WEST II SCRUBBER #840 STACK		
S15	(5) FLOURINE WEST II SCRUBBER STACKS		
SENG1	FIRE PUMP ENGINE 1 STACK		
SENG2	GENERATOR 1 STACK		
SENG3	GENERATOR 2 STACK		
SENG4	GENERATOR 3 STACK		
Z07	FUGITIVE EMISSIONS		

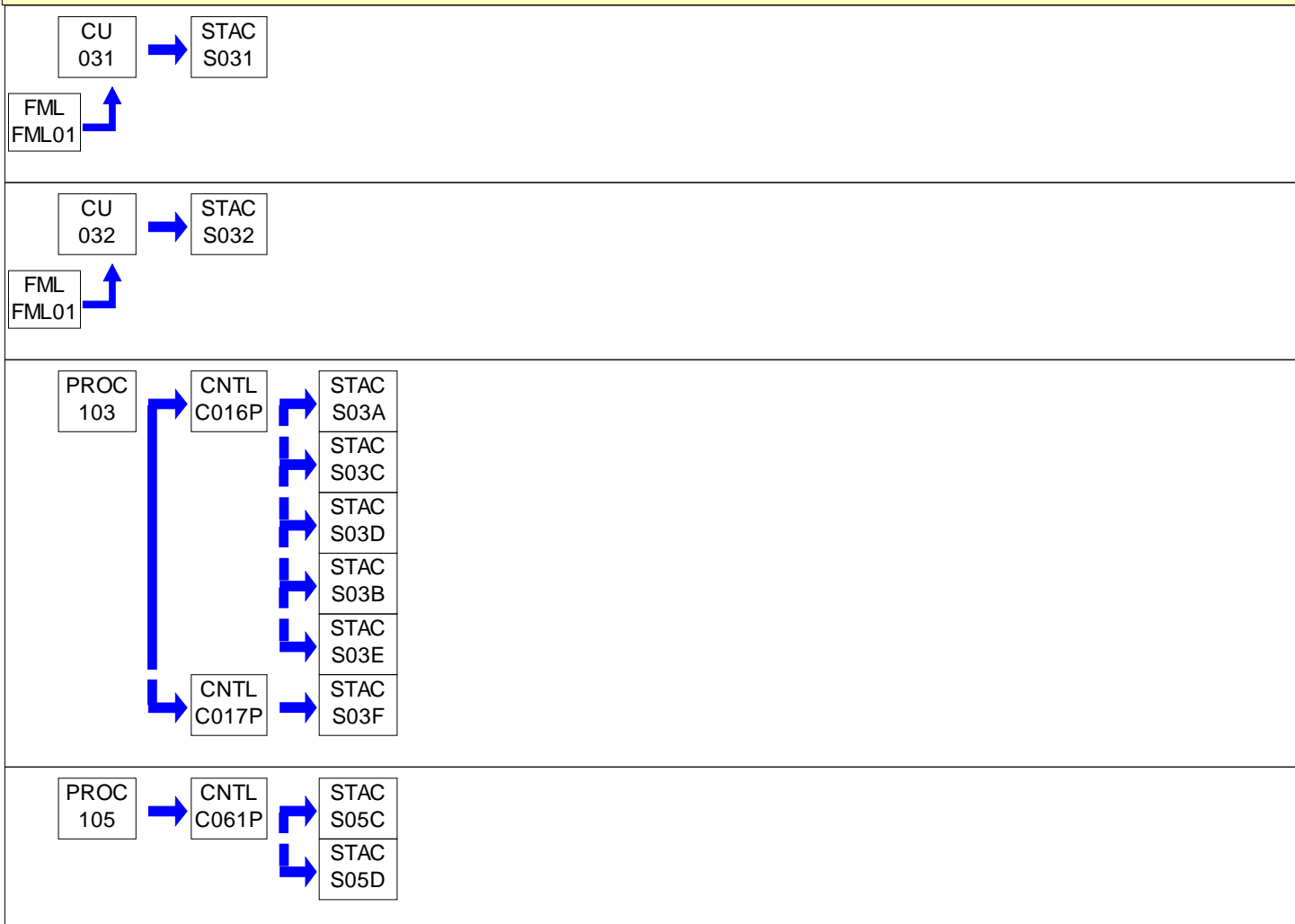
**PERMIT MAPS**



PERMIT MAPS

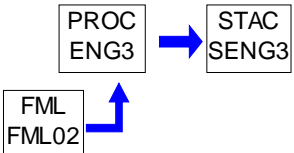
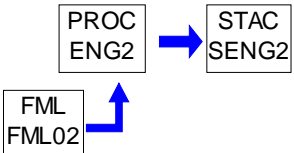
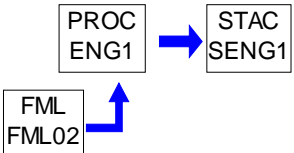
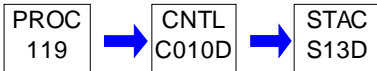
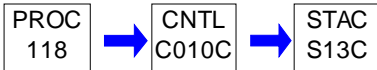
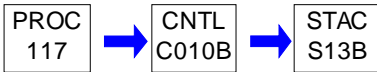
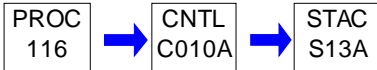
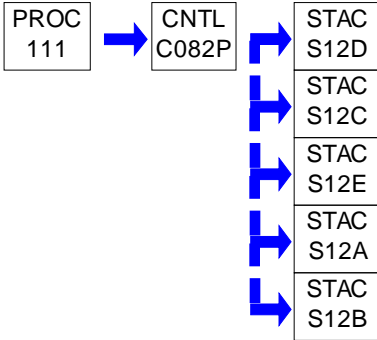



### PERMIT MAPS

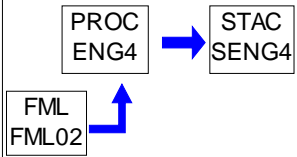

**SECTION B. General State Only Requirements****#001 [25 Pa. Code § 121.1]****Definitions.**

Words and terms that are not otherwise defined in this permit shall have the meanings set forth in Section 3 of the Air Pollution Control Act (35 P.S. § 4003) and in 25 Pa. Code § 121.1.

**#002 [25 Pa. Code § 127.446]****Operating Permit Duration.**

(a) This operating permit is issued for a fixed term of five (5) years and shall expire on the date specified on Page 1 of this permit.

(b) The terms and conditions of the expired permit shall automatically continue pending issuance of a new operating permit, provided the permittee has submitted a timely and complete application and paid applicable fees required under 25 Pa. Code Chapter 127, Subchapter I and the Department is unable, through no fault of the permittee, to issue or deny a new permit before the expiration of the previous permit.

**#003 [25 Pa. Code §§ 127.412, 127.413, 127.414, 127.446 & 127.703(b)&(c)]****Permit Renewal.**

(a) The permittee shall submit a timely and complete application for renewal of the operating permit to the appropriate Regional Air Program Manager. The application for renewal of the operating permit shall be submitted at least six (6) months and not more than 18 months before the expiration date of this permit.

(b) The application for permit renewal shall include the current permit number, a description of any permit revisions that occurred during the permit term, and any applicable requirements that were promulgated and not incorporated into the permit during the permit term. An application is complete if it contains sufficient information to begin processing the application, has the applicable sections completed and has been signed by a responsible official.

(c) The permittee shall submit with the renewal application a fee for the processing of the application and an additional annual administrative fee as specified in 25 Pa. Code § 127.703(b) and (c). The fees shall be made payable to "The Commonwealth of Pennsylvania - Clean Air Fund" and shall be for the amount specified in the following schedule specified in 25 Pa. Code § 127.703(b) and (c).

(1) Three hundred dollars for applications filed during the 2000-2004 calendar years.

(2) Three hundred seventy-five dollars for applications filed for the calendar years beginning in 2005.

(d) The renewal application shall also include submission of proof that the local municipality and county, in which the facility is located, have been notified in accordance with 25 Pa. Code § 127.413.

(e) The application for renewal of the operating permit shall also include submission of supplemental compliance review forms in accordance with the requirements of 25 Pa. Code § 127.412(b) and § 127.412(j).

(f) The permittee, upon becoming aware that any relevant facts were omitted or incorrect information was submitted in the permit application, shall promptly submit such supplementary facts or corrected information as necessary to address any requirements that become applicable to the source after the permittee submits a complete application, but prior to the date the Department takes action on the permit application.

**#004 [25 Pa. Code § 127.703]****Operating Permit Fees under Subchapter I.**

(a) The permittee shall pay fees according to the following schedule specified in 25 Pa. Code § 127.703(b):

(1) Three hundred dollars for applications filed during the 2000-2004 calendar years.

(2) Three hundred seventy-five dollars for applications filed for the calendar years beginning in 2005.

This fee schedule shall apply to the processing of an application for an operating permit as well as the extension,



**SECTION B. General State Only Requirements**

modification, revision, renewal, and re-issuance of each operating permit or part thereof.

(b) The permittee shall pay an annual operating permit administrative fee according to the fee schedule established in 25 Pa. Code § 127.703(c).

(1) Two hundred fifty dollars for applications filed during the 1995-1999 calendar years.

(2) Three hundred dollars for applications filed during the 2000-2004 calendar years.

(3) Three hundred seventy-five dollars for applications filed during the years beginning in 2005.

(c) The applicable fees shall be made payable to "The Commonwealth of Pennsylvania - Clean Air Fund".

**#005 [25 Pa. Code §§ 127.450 (a)(4) and 127.464]****Transfer of Operating Permits.**

(a) This operating permit may not be transferred to another person, except in cases of transfer-of-ownership that are documented and approved by the Department.

(b) In accordance with 25 Pa. Code § 127.450(a)(4), a change in ownership of the source shall be treated as an administrative amendment if the Department determines that no other change in the permit is required and a written agreement has been submitted to the Department identifying the specific date of the transfer of permit responsibility, coverage and liability between the current and the new permittee and a compliance review form has been submitted to, and the permit transfer has been approved by, the Department.

(c) This operating permit is valid only for those specific sources and the specific source locations described in this permit.

**#006 [25 Pa. Code § 127.441 and 35 P.S. § 4008]****Inspection and Entry.**

(a) Upon presentation of credentials and other documents as may be required by law, the permittee shall allow the Department or authorized representatives of the Department to perform the following:

(1) Enter at reasonable times upon the permittee's premises where a source is located or emissions related activity is conducted, or where records are kept under the conditions of this permit;

(2) Have access to and copy, at reasonable times, any records that are kept under the conditions of this permit;

(3) Inspect at reasonable times, any facilities, equipment including monitoring and air pollution control equipment, practices, or operations regulated or required under this permit;

(4) Sample or monitor, at reasonable times, any substances or parameters, for the purpose of assuring compliance with the permit or applicable requirements as authorized by the Clean Air Act, the Air Pollution Control Act, or the regulations promulgated under the Acts.

(b) Pursuant to 35 P.S. § 4008, no person shall hinder, obstruct, prevent or interfere with the Department or its personnel in the performance of any duty authorized under the Air Pollution Control Act or regulations adopted thereunder including denying the Department access to a source at this facility. Refusal of entry or access may constitute grounds for permit revocation and assessment of criminal and/or civil penalties.

(c) Nothing in this permit condition shall limit the ability of the EPA to inspect or enter the premises of the permittee in accordance with Section 114 or other applicable provisions of the Clean Air Act.

**#007 [25 Pa. Code §§ 127.441 & 127.444]****Compliance Requirements.**

(a) The permittee shall comply with the conditions of this operating permit. Noncompliance with this permit constitutes

**SECTION B. General State Only Requirements**

a violation of the Clean Air Act and the Air Pollution Control Act and is grounds for one or more of the following:

- (1) Enforcement action
- (2) Permit termination, revocation and reissuance or modification
- (3) Denial of a permit renewal application

(b) A person may not cause or permit the operation of a source which is subject to 25 Pa. Code Article III unless the source(s) and air cleaning devices identified in the application for the plan approval and operating permit and the plan approval issued for the source is operated and maintained in accordance with specifications in the applications and the conditions in the plan approval and operating permit issued by the Department. A person may not cause or permit the operation of an air contamination source subject to 25 Pa. Code Chapter 127 in a manner inconsistent with good operating practices.

(c) For purposes of Sub-condition (b) of this permit condition, the specifications in applications for plan approvals and operating permits are the physical configurations and engineering design details which the Department determines are essential for the permittee's compliance with the applicable requirements in this State-Only permit. Nothing in this sub-condition shall be construed to create an independent affirmative duty upon the permittee to obtain a predetermination from the Department for physical configuration or engineering design detail changes made by the permittee.

**#008 [25 Pa. Code § 127.441]****Need to Halt or Reduce Activity Not a Defense.**

It shall not be a defense for the permittee in an enforcement action that it was necessary to halt or reduce the permitted activity in order to maintain compliance with the conditions of this permit.

**#009 [25 Pa. Code §§ 127.442(a) & 127.461]****Duty to Provide Information.**

(a) The permittee shall submit reports to the Department containing information the Department may prescribe relative to the operation and maintenance of each source at the facility.

(b) The permittee shall furnish to the Department, in writing, information that the Department may request to determine whether cause exists for modifying, revoking and reissuing, or terminating this permit, or to determine compliance with the permit. Upon request, the permittee shall also furnish to the Department copies of records that the permittee is required to maintain in accordance with this permit.

**#010 [25 Pa. Code § 127.461]****Revising an Operating Permit for Cause.**

This operating permit may be terminated, modified, suspended or revoked and reissued if one or more of the following applies:

- (1) The permittee constructs or operates the source subject to the operating permit so that it is in violation of the Air Pollution Control Act, the Clean Air Act, the regulations thereunder, a plan approval, a permit or in a manner that causes air pollution.
- (2) The permittee fails to properly or adequately maintain or repair an air pollution control device or equipment attached to or otherwise made a part of the source.
- (3) The permittee has failed to submit a report required by the operating permit or an applicable regulation.
- (4) The EPA determines that the permit is not in compliance with the Clean Air Act or the regulations thereunder.

**#011 [25 Pa. Code §§ 127.450 & 127.462]****Operating Permit Modifications**

(a) The permittee is authorized to make administrative amendments, minor operating permit modifications and

**SECTION B. General State Only Requirements**

significant operating permit modifications, under this permit, as outlined below:

(b) Administrative Amendments. The permittee shall make administrative operating permit amendments (as defined in 25 Pa. Code § 127.450(a)), according to procedures specified in § 127.450 unless precluded by the Clean Air Act or its regulations.

(c) Minor Operating Permit Modifications. The permittee shall make minor operating permit modifications (as defined 25 Pa. Code § 121.1) in accordance with 25 Pa. Code § 127.462.

(d) Permit modifications which do not qualify as minor permit modifications under 25 Pa. Code § 127.541 will be treated as a significant operating permit revision subject to the public notification procedures in §§ 127.424 and 127.425.

**#012 [25 Pa. Code § 127.441]****Severability Clause.**

The provisions of this permit are severable, and if any provision of this permit is determined by a court of competent jurisdiction to be invalid or unenforceable, such a determination will not affect the remaining provisions of this permit.

**#013 [25 Pa. Code § 127.449]****De Minimis Emission Increases.**

(a) This permit authorizes de minimis emission increases in accordance with 25 Pa. Code § 127.449 so long as the permittee provides the Department with seven (7) days prior written notice before commencing any de minimis emissions increase. The written notice shall:

(1) Identify and describe the pollutants that will be emitted as a result of the de minimis emissions increase.

(2) Provide emission rates expressed in tons per year and in terms necessary to establish compliance consistent with any applicable requirement.

(b) The Department may disapprove or condition de minimis emission increases at any time.

(c) Except as provided below in (d), the permittee is authorized to make de minimis emission increases (expressed in tons per year) up to the following amounts without the need for a plan approval or prior issuance of a permit modification:

(1) Four tons of carbon monoxide from a single source during the term of the permit and 20 tons of carbon monoxide at the facility during the term of the permit.

(2) One ton of NO<sub>x</sub> from a single source during the term of the permit and 5 tons of NO<sub>x</sub> at the facility during the term of the permit.

(3) One and six-tenths tons of the oxides of sulfur from a single source during the term of the permit and 8.0 tons of oxides of sulfur at the facility during the term of the permit.

(4) Six-tenths of a ton of PM<sub>10</sub> from a single source during the term of the permit and 3.0 tons of PM<sub>10</sub> at the facility during the term of the permit. This shall include emissions of a pollutant regulated under Section 112 of the Clean Air Act unless precluded by the Clean Air Act, the regulations thereunder or 25 Pa. Code Article III.

(5) One ton of VOCs from a single source during the term of the permit and 5.0 tons of VOCs at the facility during the term of the permit. This shall include emissions of a pollutant regulated under Section 112 of the Clean Air Act unless precluded by the Clean Air Act, the regulations thereunder or 25 Pa. Code Article III.

(6) Other sources and classes of sources determined to be of minor significance by the Department.

(d) In accordance with § 127.14, the permittee is authorized to install the following minor sources without the need for a plan approval or permit modification:

**SECTION B. General State Only Requirements**

- (1) Air conditioning or ventilation systems not designed to remove pollutants generated or released from other sources.
  - (2) Combustion units rated at 2,500,000 or less Btu per hour of heat input.
  - (3) Combustion units with a rated capacity of less than 10,000,000 Btu per hour heat input fueled by natural gas supplied by a public utility or by commercial fuel oils which are No. 2 or lighter, viscosity less than or equal to 5.82 c St, and which meet the sulfur content requirements of 25 Pa. Code §123.22 (relating to combustion units). For purposes of this permit, commercial fuel oil shall be virgin oil which has no reprocessed, recycled or waste material added.
  - (4) Space heaters which heat by direct heat transfer.
  - (5) Laboratory equipment used exclusively for chemical or physical analysis.
  - (6) Other sources and classes of sources determined to be of minor significance by the Department.
- (e) This permit does not authorize de minimis emission increases if the emissions increase would cause one or more of the following:
- (1) Increase the emissions of a pollutant regulated under Section 112 of the Clean Air Act except as authorized in Subparagraphs (c)(4) and (5) of this permit condition.
  - (2) Subject the facility to the prevention of significant deterioration requirements in 25 Pa. Code Chapter 127, Subchapter D and/or the new source review requirements in Subchapter E.
  - (3) Violate any applicable requirement of this permit, the Air Pollution Control Act, the Clean Air Act, or the regulations promulgated under either of the acts.
- (f) Emissions authorized under this permit condition shall be included in the monitoring, recordkeeping and reporting requirements of this permit.
- (g) Except for de minimis emission increases, installation of minor sources made pursuant to this permit condition and Plan Approval Exemptions under 25 Pa. Code § 127.14 (relating to exemptions), the permittee is prohibited from making changes or engaging in activities that are not specifically authorized under this permit without first applying for a plan approval. In accordance with § 127.14(b), a plan approval is not required for the construction, modification, reactivation, or installation of the sources creating the de minimis emissions increase.
- (h) The permittee may not meet de minimis emission threshold levels by offsetting emission increases or decreases at the same source.

**#014 [25 Pa. Code § 127.3]****Operational Flexibility.**

The permittee is authorized to make changes within the facility in accordance with the regulatory provisions outlined in 25 Pa. Code § 127.3 (relating to operational flexibility) to implement the operational flexibility requirements provisions authorized under Section 6.1(i) of the Air Pollution Control Act and the operational flexibility terms and conditions of this permit. The provisions in 25 Pa. Code Chapter 127 which implement the operational flexibility requirements include the following:

- (1) Section 127.14 (relating to exemptions)
- (2) Section 127.447 (relating to alternative operating scenarios)
- (3) Section 127.448 (relating to emissions trading at facilities with Federally enforceable emissions caps)
- (4) Section 127.449 (relating to de minimis emission increases)
- (5) Section 127.450 (relating to administrative operating permit amendments)

**SECTION B. General State Only Requirements**

(6) Section 127.462 (relating to minor operating permit modifications)

(7) Subchapter H (relating to general plan approvals and general operating permits)

**#015 [25 Pa. Code § 127.11]****Reactivation**

(a) The permittee may not reactivate a source that has been out of operation or production for at least one year unless the reactivation is conducted in accordance with a plan approval granted by the Department or in accordance with reactivation and maintenance plans developed and approved by the Department in accordance with 25 Pa. Code § 127.11a(a).

(b) A source which has been out of operation or production for more than five (5) years but less than 10 years may be reactivated and will not be considered a new source if the permittee satisfies the conditions specified in 25 Pa. Code § 127.11a(b).

**#016 [25 Pa. Code § 127.36]****Health Risk-based Emission Standards and Operating Practice Requirements.**

(a) When needed to protect public health, welfare and the environment from emissions of hazardous air pollutants from new and existing sources, the permittee shall comply with the health risk-based emission standards or operating practice requirements imposed by the Department, except as precluded by §§ 6.6(d)(2) and (3) of the Air Pollution Control Act [35 P.S. § 4006.6(d)(2) and (3)].

(b) A person challenging a performance or emission standard established by the Department has the burden to demonstrate that performance or emission standard does not meet the requirements of Section 112 of the Clean Air Act.

**#017 [25 Pa. Code § 121.9]****Circumvention.**

No person may permit the use of a device, stack height which exceeds good engineering practice stack height, dispersion technique or other technique which, without resulting in reduction of the total amount of air contaminants emitted, conceals or dilutes an emission of air contaminants which would otherwise be in violation of 25 Pa. Code Article III, except that with prior approval of the Department, the device or technique may be used for control of malodors.

**#018 [25 Pa. Code §§ 127.402(d) & 127.442]****Reporting Requirements.**

(a) The permittee shall comply with the applicable reporting requirements of the Clean Air Act, the regulations thereunder, the Air Pollution Control Act and 25 Pa. Code Article III including Chapters 127, 135 and 139.

(b) The permittee shall submit reports to the Department containing information the Department may prescribe relative to the operation and maintenance of any air contamination source.

(c) Reports, test data, monitoring data, notifications and requests for renewal of the permit shall be submitted to the:

Regional Air Program Manager  
PA Department of Environmental Protection  
(At the address given in the permit transmittal letter, or otherwise notified)

(d) Any records or information including applications, forms, or reports submitted pursuant to this permit condition shall contain a certification by a responsible official as to truth, accuracy and completeness. The certifications submitted under this permit shall require a responsible official of the facility to certify that based on information and belief formed after reasonable inquiry, the statements and information in the documents are true, accurate and complete.

(e) Any records, reports or information submitted to the Department shall be available to the public except for such

**SECTION B. General State Only Requirements**

records, reports or information which meet the confidentiality requirements of § 4013.2 of the Air Pollution Control Act and §§ 112(d) and 114(c) of the Clean Air Act. The permittee may not request a claim of confidentiality for any emissions data generated for the facility.

**#019 [25 Pa. Code §§ 127.441(c) & 135.5]****Sampling, Testing and Monitoring Procedures.**

(a) The permittee shall comply with the monitoring, recordkeeping or reporting requirements of 25 Pa. Code Chapter 139 and the other applicable requirements of 25 Pa. Code Article III and additional requirements related to monitoring, reporting and recordkeeping required by the Clean Air Act and the regulations thereunder including the Compliance Assurance Monitoring requirements of 40 CFR Part 64, where applicable.

(b) Unless alternative methodology is required by the Clean Air Act and regulations adopted thereunder, sampling, testing and monitoring required by or used by the permittee to demonstrate compliance with any applicable regulation or permit condition shall be conducted in accordance with the requirements of 25 Pa. Code Chapter 139.

**#020 [25 Pa. Code §§ 127.441(c) and 135.5]****Recordkeeping.**

(a) The permittee shall maintain and make available, upon request by the Department, the following records of monitored information:

- (1) The date, place (as defined in the permit) and time of sampling or measurements.
- (2) The dates the analyses were performed.
- (3) The company or entity that performed the analyses.
- (4) The analytical techniques or methods used.
- (5) The results of the analyses.
- (6) The operating conditions as existing at the time of sampling or measurement.

(b) The permittee shall retain records of any required monitoring data and supporting information for at least five (5) years from the date of the monitoring, sample, measurement, report or application. Supporting information includes the calibration data and maintenance records and original strip-chart recordings for continuous monitoring instrumentation, and copies of reports required by the permit.

(c) The permittee shall maintain and make available to the Department upon request, records including computerized records that may be necessary to comply with the reporting, recordkeeping and emission statement requirements in 25 Pa. Code Chapter 135 (relating to reporting of sources). In accordance with 25 Pa. Code Chapter 135, § 135.5, such records may include records of production, fuel usage, maintenance of production or pollution control equipment or other information determined by the Department to be necessary for identification and quantification of potential and actual air contaminant emissions.

**#021 [25 Pa. Code § 127.441(a)]****Property Rights.**

This permit does not convey any property rights of any sort, or any exclusive privileges.

**#022 [25 Pa. Code § 127.447]****Alternative Operating Scenarios.**

The permittee is authorized to make changes at the facility to implement alternative operating scenarios identified in this permit in accordance with 25 Pa. Code § 127.447.

**SECTION C. Site Level Requirements****I. RESTRICTIONS.****Emission Restriction(s).****# 001 [25 Pa. Code §123.1]****Prohibition of certain fugitive emissions**

(a) No person may permit the emission into the outdoor atmosphere of fugitive air contaminant from a source other than the following:

- (1) Construction or demolition of buildings or structures.
- (2) Grading, paving and maintenance of roads and streets.
- (3) Use of roads and streets. Emissions from material in or on trucks, railroad cars and other vehicular equipment are not considered as emissions from use of roads and streets.
- (4) Clearing of land.
- (5) Stockpiling of materials.
- (6) Open burning operations.
- (7) Blasting in open pit mines. Emissions from drilling are not considered as emissions from blasting.
- (8) Coke oven batteries, provided the fugitive air contaminants emitted from any coke oven battery comply with the standards for visible fugitive emissions in § § 123.44 and 129.15 (relating to limitations of visible fugitive air contaminants from operation of any coke oven battery; and coke pushing operations).
- (9) Sources and classes of sources other than those identified in paragraphs (1)-(8), for which the operator has obtained a determination from the Department that fugitive emissions from the source, after appropriate control, meet the following requirements:
  - (i) the emissions are of minor significance with respect to causing air pollution; and
  - (ii) the emissions are not preventing or interfering with the attainment or maintenance of any ambient air quality standard.

**# 002 [25 Pa. Code §123.2]****Fugitive particulate matter**

The permittee may not permit fugitive particulate matter to be emitted into the outdoor atmosphere from a source specified in Site Level Condition #001 (relating to prohibition of certain fugitive emissions) if such emissions are visible at the point the emissions pass outside the person's property.

**# 003 [25 Pa. Code §123.31]****Limitations****MALODOR EMISSIONS**

The permittee may not permit the emission into the outdoor atmosphere of any malodorous air contaminants from any source in such a manner that the malodors are detectable outside the property of the person on whose land the source is being operated.

**# 004 [25 Pa. Code §123.41]****Limitations****VISIBLE EMISSIONS**

(a) A person may not permit the emission into the outdoor atmosphere of visible air contaminants in such a manner that the opacity of the emission is either of the following:

- (1) Equal to or greater than 20% for a period or periods aggregating more than three minutes in any 1 hour.
- (2) Equal to or greater than 60% at any time.

**SECTION C. Site Level Requirements**

(b) The limitations of section (a) shall not apply to a visible emission in any of the following instances:

- (1) When the presence of uncombined water is the only reason for failure of the emission to meet the limitations.
- (2) When the emission results from the operation of equipment used solely to train and test persons in observing the opacity of visible emission.
- (3) When the emission results from sources specified in Site Level Condition #001 (relating to prohibition of certain fugitive emissions).

**II. TESTING REQUIREMENTS.****# 005 [25 Pa. Code §127.441]****Operating permit terms and conditions.**

If at any time the Department has cause to believe air contaminant emissions from any source(s) may be in excess of the limitations specified in, or established pursuant to, any applicable rule or regulation contained in Article III of the Rules and Regulations of the Department of Environmental Protection, the company shall be required to conduct whatever tests are deemed necessary by the Department to determine the actual emission rate(s).

Such testing shall be conducted in accordance with the revisions of Chapter 139 of the Rules and Regulations Environmental Protection, where applicable, and in accordance with any restrictions or limitations established by the Department at such time as it notifies the company that testing is required.

**# 006 [25 Pa. Code §127.511]****Monitoring and related recordkeeping and reporting requirements.**

All sampling, testing and analyses performed in compliance with the requirements of any section of this permit shall be done in accordance with Section B, Condition #019.

**# 007 [25 Pa. Code §127.511]****Monitoring and related recordkeeping and reporting requirements.**

[Authority for this condition is also derived from 25 Pa. Code, Section 129.92.]

(a) If requested by the Department, the permittee shall perform a stack test within the time frame specified by the Department.

(b) All performance tests shall be conducted in accordance with 40 CFR Part 60, Section 60.754 and the Department's source testing procedures described in the latest Source Testing Manual reference in 25 Pa. Code, Section 139.4(5).

**# 008 [25 Pa. Code §139.1]****Sampling facilities.**

Upon the request of the Department, the permittee shall provide adequate sampling ports, safe sampling platforms and adequate utilities for the performance by the Department of tests on such source. The Department will set forth, in the request, the time period in which the facilities shall be provided as well as the specifications for such facilities.

**# 009 [25 Pa. Code §139.11]****General requirements.**

(a) As specified in 25 Pa. Code Section 139.11(1), performance tests shall be conducted while the source is operating at maximum routine operating conditions or under such other conditions, within the capacity of the equipment, as may be requested by the Department.

(b) As specified in 25 Pa. Code Section 139.11(2), the Department will consider test results for approval where sufficient information is provided to verify the source conditions existing at the time of the test and where adequate data is available to show the manner in which the test was conducted. Information submitted to the Department shall include, as a minimum, all of the following:

- (1) A thorough source description, including a description of any air cleaning devices and the flue.
- (2) Process conditions, for example, the charging rate of raw material or rate of production of final product, boiler pressure, oven temperature and other conditions which may affect emissions from the process.



**SECTION C. Site Level Requirements**

- (3) The location of sampling ports.
- (4) Effluent characteristics, including velocity, temperature, moisture content, gas density (percentage of CO, CO<sub>2</sub>, O<sub>2</sub> and N<sub>2</sub>), static and barometric pressures.
- (5) Sample collection techniques employed, including procedures used, equipment descriptions and data to verify that isokinetic sampling for particulate matter collection occurred and that acceptable test conditions were met.
- (6) Laboratory procedures and results.
- (7) Calculated results.

**III. MONITORING REQUIREMENTS.****# 010 [25 Pa. Code §123.43]****Measuring techniques**

Visible emissions may be measured using either of the following:

- (a) A device approved by the Department and maintained to provide accurate opacity measurements.
- (b) Observers, trained and qualified to measure plume opacity with the naked eye or with the aid of any devices approved by the Department.

**# 011 [25 Pa. Code §127.511]****Monitoring and related recordkeeping and reporting requirements.**

The permittee shall conduct weekly inspections of the facility, during daylight hours when the plant is in operation, to detect visible, fugitive, and malodor emissions as follows:

- (a) Visible emissions in excess of the limits stated in this permit. Visible emissions may be measured according to the methods specified in Section C, Condition #010, or alternatively, plant personnel who observe any visible emissions (i.e. emissions in excess of 0% opacity) will report the incident of visible emissions to the Department within four (4) hours of each incident and make arrangements for a certified observer to verify the opacity of the emissions.
- (b) The presence of fugitive and malodor emissions visible beyond the boundaries of the facility, as stated in Section C, Conditions #002 and #003.

**IV. RECORDKEEPING REQUIREMENTS.****# 012 [25 Pa. Code §127.511]****Monitoring and related recordkeeping and reporting requirements.**

All records, reports, and test results generated in compliance with the requirements of any section of this permit shall be maintained for a minimum of 5 years in accordance with Section B, Condition #020 and shall be made available to the Department upon written or verbal request at a reasonable time.

**# 013 [25 Pa. Code §127.511]****Monitoring and related recordkeeping and reporting requirements.**

- (a) The permittee shall, at the conclusion of each weekly inspection, record all occurrences of fugitive, visible, or malodor emissions which deviate from the limitations of Section C, Conditions #002, #003, and #004 in a log book.
- (b) The permittee shall record any and all corrective action(s) taken to abate each recorded deviation and to prevent future occurrences.

**# 014 [25 Pa. Code §127.511]****Monitoring and related recordkeeping and reporting requirements.**

The facilities emissions shall be updated monthly and maintained on a 12-month rolling sum.

**V. REPORTING REQUIREMENTS.****# 015 [25 Pa. Code §127.441]****Operating permit terms and conditions.**

The company, within one (1) hour of occurrence, shall notify the Department, at (570) 826-2511, of any malfunction, recordkeeping and reporting errors, or other possible non-compliance issues, which result in, or may possibly be resulting in, the emission of air contaminants in excess of the limitations specified in, or established pursuant to, any applicable rule or regulations contained in Article III of the Rules and Regulations of the Department of Environmental Protection. A written

**SECTION C. Site Level Requirements**

report shall be submitted to the Department within five working days following the incident describing the malfunction, recordkeeping and reporting error or other non-compliance issue and the corrective actions being taken. The Department may take enforcement action for any violations of the applicable standards.

**# 016 [25 Pa. Code §127.511]****Monitoring and related recordkeeping and reporting requirements.**

(a) On a semi-annual basis, the permittee shall compile a report of all logged instances of deviation of the fugitive, visible, or malodor emission limitations that occurred and the actions taken in response to them. This report shall be submitted to the Department.

(b) If no deviations have been logged during the reported period, this report shall be retained at the facility and be made available to the Department upon request.

**# 017 [25 Pa. Code §135.21]****Emission statements**

(a) Except as provided in subsection (d), this section applies to stationary sources or facilities:

(1) Located in an area designated by the Clean Air Act as a marginal, moderate, serious, severe or extreme ozone nonattainment area and which emit oxides of nitrogen or VOC.

(2) Not located in an area described in subparagraph (1) and included in the Northeast Ozone Transport Region which emit or have the potential to emit 100 tons or more oxides of nitrogen or 50 tons or more of VOC per year.

(b) The owner or operator of each stationary source emitting oxides of nitrogen or VOC's shall provide the Department with a statement, in a form as the Department may prescribe, for classes or categories of sources, showing the actual emissions of oxides of nitrogen and VOCs from that source for each reporting period, a description of the method used to calculate the emissions and the time period over which the calculation is based. The statement shall contain a certification by a company officer or the plant manager that the information contained in the statement is accurate.

(c) Annual emission statements are due by March 1 for the preceding calendar year beginning with March 1, 1993, for calendar year 1992 and shall provide data consistent with requirements and guidance developed by the EPA. The guidance document is available from: United States Environmental Protection Agency, 401 M. Street, S.W., Washington, D.C. 20460. The Department may require more frequent submittals if the Department determines that one or more of the following applies:

(1) A more frequent submission is required by the EPA.

(2) Analysis of the data on a more frequent basis is necessary to implement the requirements of the act.

(d) Subsection (a) does not apply to a class or category of stationary sources which emits less than 25 tons per year of VOC's or oxides of nitrogen, if the Department in its submissions to the Administrator of the EPA under section 182(a)(1) or (3)(B)(ii) of the Clean Air Act (42 U.S.C.A. 7511a(a)(1) or (3)(B)(ii)) provides an inventory of emissions from the class or category of sources based on the use of the emission factors established by the Administrator or other methods acceptable to the Administrator. The Department will publish in the Pennsylvania Bulletin a notice of the lists of classes or categories of sources which are exempt from the emission statement requirement under this subsection.

**# 018 [25 Pa. Code §135.3]****Reporting**

(a) A person who owns or operates a source to which this chapter applies, and who has previously been advised by the Department to submit a source report, shall submit by March 1 of each year a source report for the preceding calendar year. The report shall include information for all previously reported sources, new sources which were first operated during the preceding calendar year and sources modified during the same period which were not previously reported.

(b) A person who receives initial notification by the Department that a source report is necessary shall submit an initial source report within 60 days after receiving the notification or by March 1 of the year following the year for which the report is required, whichever is later.

(c) A source owner or operator may request an extension of time from the Department for the filing of a source report, and the Department may grant the extension for reasonable cause.

**SECTION C. Site Level Requirements****VI. WORK PRACTICE REQUIREMENTS.****# 019 [25 Pa. Code §123.1]****Prohibition of certain fugitive emissions**

The permittee shall take all reasonable actions to prevent particulate matter from becoming airborne. These actions shall include, but not be limited to, the following:

- (a) Use, where possible, of water or chemicals for control of dust in the demolition of buildings or structures, construction operations, the grading of roads, or the clearing of land.
- (b) Application of asphalt, oil, water or suitable chemicals on dirt roads, material stockpiles and other surfaces which may give rise to airborne dusts.
- (c) Paving and maintenance of roadways.
- (d) Prompt removal of earth or other material from paved streets onto which earth or other material has been transported by trucking or earth moving equipment, erosion by water, or other means.

**# 020 [25 Pa. Code §127.441]****Operating permit terms and conditions.**

The permittee shall ensure all sources capture systems and control devices are in operation at all times the source(s) are operating.

**# 021 [25 Pa. Code §129.14]****Open burning operations**

- (a) No person may permit the open burning of material in an area outside of air basins in a manner that:
  - (1) The emissions are visible, at any time, at the point such emissions pass outside the property of the person on whose land the open burning is being conducted.
  - (2) Malodorous air contaminants from the open burning are detectable outside the property of the person on whose land the open burning is being conducted.
  - (3) The emissions interfere with the reasonable enjoyment of life or property.
  - (4) The emissions cause damage to vegetation or property.
  - (5) The emissions are or may be deleterious to human or animal health.
- (b) Exceptions: The requirements of subsection (a) does not apply where the open burning operations result from:
  - (1) A fire set to prevent or abate a fire hazard, when approved by the Department and set by or under the supervision of a public officer.
  - (2) A fire set for the purpose of instructing personnel in fire fighting, when approved by the Department.
  - (3) A fire set for the prevention and control of disease or pests, when approved by the Department.
  - (4) A fire set in conjunction with the production of agricultural commodities in their unmanufactured state on the premises of the farm operation.
  - (5) A fire set for the purpose of burning domestic refuse, when the fire is on the premises of a structure occupied solely as a dwelling by two families or less and when the refuse results from the normal occupancy of such structure.
  - (6) A fire set solely for recreational or ceremonial purposes.
  - (7) A fire set solely for cooking food.

**SECTION C. Site Level Requirements****VII. ADDITIONAL REQUIREMENTS.****# 022 [25 Pa. Code §127.441]****Operating permit terms and conditions.**

The oil fired boiler sources at the facility are subject to 40 CFR 63, Subpart JJJJJJ, National Emission Standards for Hazardous Air Pollutants for Industrial, Commercial, and Institutional Boilers Area Sources.

**# 023 [25 Pa. Code §127.441]****Operating permit terms and conditions.**

The company shall not impose conditions upon or otherwise restrict the Department's access to any source(s) and/or associated air cleaning device(s) and shall allow the Department to have access at any time to said source(s) and associated air cleaning device(s) with such measuring and recording equipment, including equipment recording visual observations, as the Department deems necessary and proper for performing its duties and for the effective enforcement of the Air Pollution Control Act.

**VIII. COMPLIANCE CERTIFICATION.**

No additional compliance certifications exist except as provided in other sections of this permit including Section B (relating to State Only General Requirements).

**IX. COMPLIANCE SCHEDULE.**

No compliance milestones exist.

**SECTION D. Source Level Requirements**

Source ID: 031

Source Name: WEST 2 BOILER 1

Source Capacity/Throughput: 14.700 MMBTU/HR

Conditions for this source occur in the following groups: GROUP 3

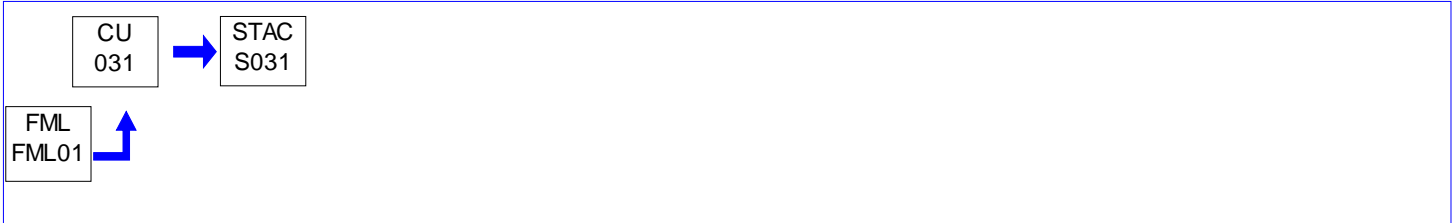
**I. RESTRICTIONS.**

No additional requirements exist except as provided in other sections of this permit including Section B (State Only General Requirements) and/or Section E (Source Group Restrictions).

**II. TESTING REQUIREMENTS.**

No additional testing requirements exist except as provided in other sections of this permit including Section B (State Only General Requirements) and/or Section E (Source Group Restrictions).

**III. MONITORING REQUIREMENTS.**

No additional monitoring requirements exist except as provided in other sections of this permit including Section B (State Only General Requirements) and/or Section E (Source Group Restrictions).

**IV. RECORDKEEPING REQUIREMENTS.**

No additional record keeping requirements exist except as provided in other sections of this permit including Section B (State Only General Requirements) and/or Section E (Source Group Restrictions).

**V. REPORTING REQUIREMENTS.**

No additional reporting requirements exist except as provided in other sections of this permit including Section B (State Only General Requirements) and/or Section E (Source Group Restrictions).

**VI. WORK PRACTICE REQUIREMENTS.**

No additional work practice requirements exist except as provided in other sections of this permit including Section B (State Only General Requirements) and/or Section E (Source Group Restrictions).

**VII. ADDITIONAL REQUIREMENTS.**

No additional requirements exist except as provided in other sections of this permit including Section B (State Only General Requirements) and/or Section E (Source Group Restrictions).

**SECTION D. Source Level Requirements**

Source ID: 032

Source Name: WEST 2 BOILER 2

Source Capacity/Throughput: 14.700 MMBTU/HR

Conditions for this source occur in the following groups: GROUP 3

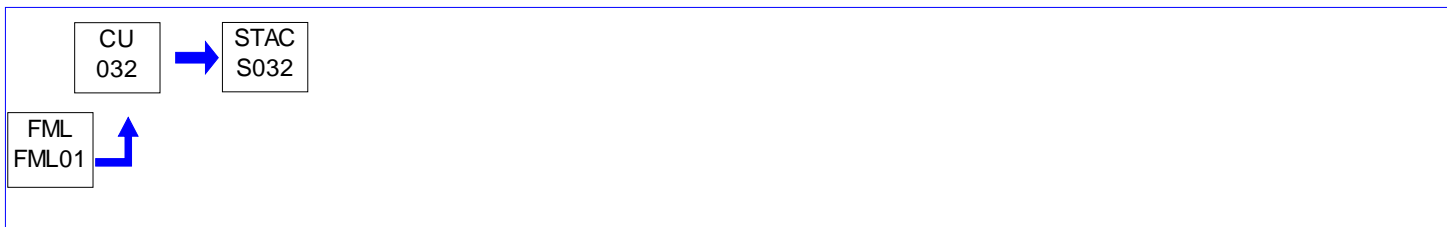
**I. RESTRICTIONS.**

No additional requirements exist except as provided in other sections of this permit including Section B (State Only General Requirements) and/or Section E (Source Group Restrictions).

**II. TESTING REQUIREMENTS.**

No additional testing requirements exist except as provided in other sections of this permit including Section B (State Only General Requirements) and/or Section E (Source Group Restrictions).

**III. MONITORING REQUIREMENTS.**

No additional monitoring requirements exist except as provided in other sections of this permit including Section B (State Only General Requirements) and/or Section E (Source Group Restrictions).

**IV. RECORDKEEPING REQUIREMENTS.**

No additional record keeping requirements exist except as provided in other sections of this permit including Section B (State Only General Requirements) and/or Section E (Source Group Restrictions).

**V. REPORTING REQUIREMENTS.**

No additional reporting requirements exist except as provided in other sections of this permit including Section B (State Only General Requirements) and/or Section E (Source Group Restrictions).

**VI. WORK PRACTICE REQUIREMENTS.**

No additional work practice requirements exist except as provided in other sections of this permit including Section B (State Only General Requirements) and/or Section E (Source Group Restrictions).

**VII. ADDITIONAL REQUIREMENTS.**

No additional requirements exist except as provided in other sections of this permit including Section B (State Only General Requirements) and/or Section E (Source Group Restrictions).

**SECTION D. Source Level Requirements**

Source ID: 103

Source Name: FLUORINE CHEM OPERATIONS

Source Capacity/Throughput:

Conditions for this source occur in the following groups: GROUP 1

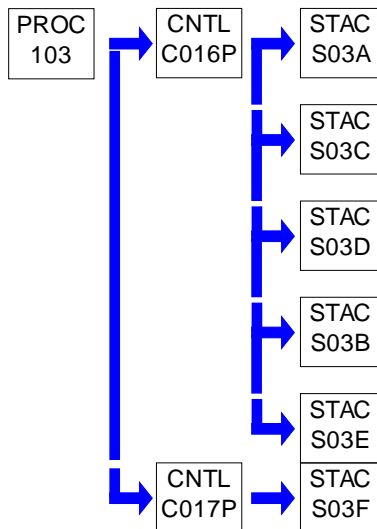
**I. RESTRICTIONS.**

No additional requirements exist except as provided in other sections of this permit including Section B (State Only General Requirements) and/or Section E (Source Group Restrictions).

**II. TESTING REQUIREMENTS.**

No additional testing requirements exist except as provided in other sections of this permit including Section B (State Only General Requirements) and/or Section E (Source Group Restrictions).

**III. MONITORING REQUIREMENTS.****# 001 [25 Pa. Code §127.441]****Operating permit terms and conditions.**

The permittee shall monitor each scrubber absorbent media (KOH) concentration once per week. An alarm system shall be installed, operated and maintained such that plant personnel are signaled when there is a reduction in flow rate through the scrubber(s). At no time may a scrubber operate when there is a reduction of flow below acceptable levels.

**IV. RECORDKEEPING REQUIREMENTS.**

No additional record keeping requirements exist except as provided in other sections of this permit including Section B (State Only General Requirements) and/or Section E (Source Group Restrictions).

**V. REPORTING REQUIREMENTS.**

No additional reporting requirements exist except as provided in other sections of this permit including Section B (State Only General Requirements) and/or Section E (Source Group Restrictions).

**VI. WORK PRACTICE REQUIREMENTS.**

No additional work practice requirements exist except as provided in other sections of this permit including Section B (State Only General Requirements) and/or Section E (Source Group Restrictions).

**SECTION D. Source Level Requirements****VII. ADDITIONAL REQUIREMENTS.****# 002 [25 Pa. Code §127.441]****Operating permit terms and conditions.**

Compliance with this operating permit by this source will be contingent upon the satisfactory demonstration that the odors from this process will not be in violation of Section 123.31 of Chapter 123 of the Rules and Regulations of the Department of Environmental Protection.



**SECTION D. Source Level Requirements**

Source ID: 105

Source Name: RESIDUAL GAS TREATMENT OPERATION

Source Capacity/Throughput:

Conditions for this source occur in the following groups: GROUP 1

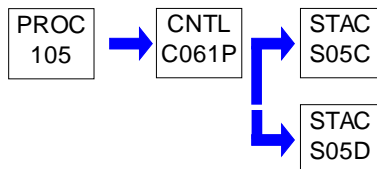
**I. RESTRICTIONS.****Control Device Efficiency Restriction(s).**

# 001 [25 Pa. Code §127.441]

**Operating permit terms and conditions.**

The Cylinder Evacuation and Vent Booth Scrubbers (Control Device C061) shall each be operated at an overall removal efficiency of no less than 99%.

**II. TESTING REQUIREMENTS.**

No additional testing requirements exist except as provided in other sections of this permit including Section B (State Only General Requirements) and/or Section E (Source Group Restrictions).

**III. MONITORING REQUIREMENTS.**

# 002 [25 Pa. Code §127.441]

**Operating permit terms and conditions.**

(a) The permittee shall operate and maintain differential pressure gauges on the two scrubbers (Control Device C061).

(b) The permittee shall, on a daily basis, check and record the pressure drop across the two scrubbers (Control Devices C061). The results of the inspections shall be made available to the Department upon request.

# 003 [25 Pa. Code §127.441]

**Operating permit terms and conditions.**

The permittee shall check the aqueous KOH solution concentration of the scrubber fluid in the two (2) scrubbers (Control Device C061) on a daily basis.

**IV. RECORDKEEPING REQUIREMENTS.**

No additional record keeping requirements exist except as provided in other sections of this permit including Section B (State Only General Requirements) and/or Section E (Source Group Restrictions).

**V. REPORTING REQUIREMENTS.**

No additional reporting requirements exist except as provided in other sections of this permit including Section B (State Only General Requirements) and/or Section E (Source Group Restrictions).

**VI. WORK PRACTICE REQUIREMENTS.**

No additional work practice requirements exist except as provided in other sections of this permit including Section B (State Only General Requirements) and/or Section E (Source Group Restrictions).

**SECTION D. Source Level Requirements****VII. ADDITIONAL REQUIREMENTS.****# 004 [25 Pa. Code §127.441]****Operating permit terms and conditions.**

Compliance with this operating permit by this source will be contingent upon the satisfactory demonstration that the odors from this process will not be in violation of Section 123.31 of Chapter 123 of the Rules and Regulations of the Department of Environmental Protection.

**SECTION D. Source Level Requirements**

Source ID: 106B

Source Name: TOUCH-UP PAINT BOOTHS

Source Capacity/Throughput:

Conditions for this source occur in the following groups: GROUP 1

**I. RESTRICTIONS.**

No additional requirements exist except as provided in other sections of this permit including Section B (State Only General Requirements) and/or Section E (Source Group Restrictions).

**II. TESTING REQUIREMENTS.**

No additional testing requirements exist except as provided in other sections of this permit including Section B (State Only General Requirements) and/or Section E (Source Group Restrictions).

**III. MONITORING REQUIREMENTS.**

No additional monitoring requirements exist except as provided in other sections of this permit including Section B (State Only General Requirements) and/or Section E (Source Group Restrictions).

**IV. RECORDKEEPING REQUIREMENTS.**

No additional record keeping requirements exist except as provided in other sections of this permit including Section B (State Only General Requirements) and/or Section E (Source Group Restrictions).

**V. REPORTING REQUIREMENTS.**

No additional reporting requirements exist except as provided in other sections of this permit including Section B (State Only General Requirements) and/or Section E (Source Group Restrictions).

**VI. WORK PRACTICE REQUIREMENTS.**

No additional work practice requirements exist except as provided in other sections of this permit including Section B (State Only General Requirements) and/or Section E (Source Group Restrictions).

**VII. ADDITIONAL REQUIREMENTS.**

No additional requirements exist except as provided in other sections of this permit including Section B (State Only General Requirements) and/or Section E (Source Group Restrictions).

**SECTION D. Source Level Requirements**

Source ID: 107

Source Name: F2 COLD DEGREASER

Source Capacity/Throughput:

Conditions for this source occur in the following groups: GROUP 1

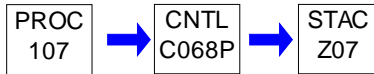
**I. RESTRICTIONS.****Control Device Efficiency Restriction(s).**

# 001 [25 Pa. Code §127.441]

**Operating permit terms and conditions.**

The refrigerant temperature of the chiller shall be maintained below 65 degrees F at all times when the chiller (Control Device C068P) is operational.

**II. TESTING REQUIREMENTS.**

No additional testing requirements exist except as provided in other sections of this permit including Section B (State Only General Requirements) and/or Section E (Source Group Restrictions).

**III. MONITORING REQUIREMENTS.**

No additional monitoring requirements exist except as provided in other sections of this permit including Section B (State Only General Requirements) and/or Section E (Source Group Restrictions).

**IV. RECORDKEEPING REQUIREMENTS.**

# 002 [25 Pa. Code §127.441]

**Operating permit terms and conditions.**

The permittee shall maintain records adequate enough to verify the amount of methylene chloride used in this source.

**V. REPORTING REQUIREMENTS.**

No additional reporting requirements exist except as provided in other sections of this permit including Section B (State Only General Requirements) and/or Section E (Source Group Restrictions).

**VI. WORK PRACTICE REQUIREMENTS.**

# 003 [25 Pa. Code §129.63]

**Degreasing operations**

Cold cleaning degreasers as defined in 25 Pa. Code, Section 121.1 (relating to definitions) which have a degreaser opening which is greater than 10 square feet shall:

(a) Be equipped with:

- (1) A cover to prevent evaporation of solvent during periods of non-use.
- (2) Equipment for draining cleaned parts.
- (3) A permanent, conspicuous label summarizing the operating requirements.

(b) Be operated in accordance with the following requirements:

- (1) Do not dispose of waste solvent or transfer it to another party, such that greater than 20% for the waste solvent (by weight) can evaporate into the atmosphere; store waste solvent only in covered containers.

**SECTION D. Source Level Requirements**

- (2) Close degreaser cover whenever not handling parts in the cleaner.
- (3) Drain cleaned parts for at least 15 seconds or until dripping ceases.

**# 004 [40 CFR Part 63 NESHAPS for Source Categories §40 CFR 63.462]****Subpart T--National Emission Standards for Halogenated Solvent Cleaning****Batch cold cleaning machine standards**

(a) Each owner or operator of an immersion batch cold solvent cleaning machine shall comply with the requirements specified in paragraph(a)(1) or (a)(2) of this section.

(1) Employ a tightly fitting cover that shall be closed at all times except during parts entry and removal, and a water layer at a minimum thickness of 2.5 centimeters (1.0 inch) on the surface of the solvent within the cleaning machine, or

(2) Employ a tightly fitting cover that shall be closed at all times except during parts entry and removal and a freeboard ratio of 0.75 or greater.

(b) Each owner or operator of a remote-reservoir batch cold solvent cleaning machine shall employ a tightly fitting cover over the solvent sump that shall be closed at all times except during the cleaning of parts.

(c) Each owner or operator of a batch cold solvent cleaning machine complying with paragraphs (a)(2) or (b) of this section shall comply with the work and operational practice requirements specified in paragraphs (c)(1) through (c)(8) of this section.

(1) All waste solvent shall be collected and stored in closed containers. The closed container may contain a device that allows pressure relief, but does not allow liquid solvent to drain from the container.

(2) If a flexible hose or flushing device is used, flushing shall be performed only within the freeboard area of the solvent cleaning machine.

(3) The owner or operator shall drain solvent cleaned parts for 15 seconds or until dripping has stopped, whichever is longer. Parts having cavities or blind holes shall be tipped or rotated while draining.

(4) The owner or operator shall ensure that the solvent level does not exceed the fill line.

(5) Spills during solvent transfer shall be wiped up immediately. The wipe rags shall be stored in covered containers meeting the requirements of paragraph (c)(1) of this section.

(6) When an air- or pump-agitated solvent bath is used, the owner or operator shall ensure that the agitator is operated to produce a rolling motion of the solvent but not observable splashing against tank walls or parts being cleaned.

(7) The owner or operator shall ensure that, when the cover is open, the cold cleaning machine is not exposed to drafts greater than 40 meters per minute (132 feet per minute), as measured between 1 and 2 meters (3.3 and 6.6 feet) upwind and at the same elevation as the tank lip.

(8) Sponges, fabric, wood, and paper products shall not be cleaned.

(d) Each owner or operator of a batch cold cleaning machine shall submit a compliance report as described in 63.468(c). [63.462(d) corrected at 60 FR 29485, June 5, 1995]

**VII. ADDITIONAL REQUIREMENTS.****# 005 [40 CFR Part 63 NESHAPS for Source Categories §40 CFR 63.468]****Subpart T--National Emission Standards for Halogenated Solvent Cleaning****Reporting requirements**

The EPA has determined, pursuant to the criteria under section 502(a) of the Act, that an owner or operator of any batch cold solvent cleaning machine that is not itself a major source and that is not located at a major source, as defined under 40 CFR 70.2, is exempt from part 70 permitting requirements for that source.

**SECTION D. Source Level Requirements**

Source ID: 111

Source Name: NF3 WEST OPERATIONS

Source Capacity/Throughput:

Conditions for this source occur in the following groups: GROUP 1

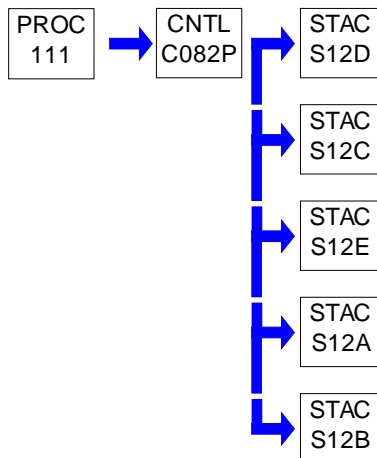
**I. RESTRICTIONS.****Emission Restriction(s).**

# 001 [25 Pa. Code §127.441]

**Operating permit terms and conditions.**

This source is subject to the following air contaminant emission limitations:

## Pollutant

NF3	262 Lb/hr, 44.1 Tons per year
HF	0.1 Lb/hr, 0.3 Tons per year
CF4	0.46 Lb/hr, 0.02 Tons per year
N2O	0.23 Lb/hr, 0.034 Tons per year
NH3	0.0002 Lb/hr, 0.048 Tons per year
N2F2	0.001 Lb/hr, 0.06 Tons per year
OF2	0.16 Lb/hr, 0.013 Tons per year
H2	25 Lb/hr, 88 Tons per year

**Throughput Restriction(s).**

# 002 [25 Pa. Code §127.441]

**Operating permit terms and conditions.**

The maximum rated capacity of the NF3 West Plant shall not exceed 250 lbs/hr of NF3.

**II. TESTING REQUIREMENTS.**

No additional testing requirements exist except as provided in other sections of this permit including Section B (State Only General Requirements) and/or Section E (Source Group Restrictions).

**III. MONITORING REQUIREMENTS.**

# 003 [25 Pa. Code §127.441]

**Operating permit terms and conditions.**

1. The company shall monitor the scrubber flows and temperatures daily. The company shall continuously monitor the scrubber absorbent media (KOH) conductivity. Alarms shall be installed that signal plant personnel when there is a reduction in the flow rate through the scrubber, differential pressure, and maximum temperature. At no time shall the

**SECTION D. Source Level Requirements**

scrubber be operated when there is a reduction of flow below acceptable levels.

2. The company shall ensure that the control devices shall be equipped with the applicable monitoring equipment and the monitoring equipment shall be installed, calibrated, operated, and maintained according to the vendor's specifications at all times the control device is in use.

**IV. RECORDKEEPING REQUIREMENTS.**

**# 004 [25 Pa. Code §127.441]**

**Operating permit terms and conditions.**

The permittee shall record the scrubber flows, scrubber temperatures, and scrubber absorbent media (KOH) conductivity on a daily basis. The recordings shall be maintained for 5 years and made available to the Department upon request.

**V. REPORTING REQUIREMENTS.**

No additional reporting requirements exist except as provided in other sections of this permit including Section B (State Only General Requirements) and/or Section E (Source Group Restrictions).

**VI. WORK PRACTICE REQUIREMENTS.**

**# 005 [25 Pa. Code §127.441]**

**Operating permit terms and conditions.**

1. The aforementioned source(s) may only be operated as long as the associated air pollution control device(s) are operated and maintained in accordance with any conditions set forth herein.

2. The company shall maintain and operates the air pollution control equipment and sources in accordance with good engineering practice.

**VII. ADDITIONAL REQUIREMENTS.**

No additional requirements exist except as provided in other sections of this permit including Section B (State Only General Requirements) and/or Section E (Source Group Restrictions).

**SECTION D. Source Level Requirements**

Source ID: 115

Source Name: FLOURINE WEST II PROCESS

Source Capacity/Throughput:

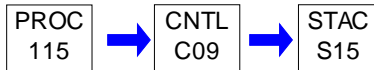
**I. RESTRICTIONS.****Emission Restriction(s).**

# 001 [25 Pa. Code §127.441]

**Operating permit terms and conditions.**

The HF (Hydrogen Fluoride) emissions from this source shall not exceed 0.7 TPY.

**II. TESTING REQUIREMENTS.**

No additional testing requirements exist except as provided in other sections of this permit including Section B (State Only General Requirements).

**III. MONITORING REQUIREMENTS.**

# 002 [25 Pa. Code §127.441]

**Operating permit terms and conditions.**

1. The company shall monitor the scrubber flows and temperatures daily. The company shall continuously monitor the scrubber absorbent media (KOH) conductivity. Alarms shall be installed that signal plant personnel when there is a reduction in the flow rate through the scrubber, differential pressure, and maximum temperature. At no time shall the scrubber be operated when there is a reduction of flow below acceptable levels.

2. The company shall ensure that the control devices shall be equipped with the applicable monitoring equipment and the monitoring equipment shall be installed, calibrated, operated, and maintained according to the vendor's specifications at all times the control device is in use.

**IV. RECORDKEEPING REQUIREMENTS.**

# 003 [25 Pa. Code §127.441]

**Operating permit terms and conditions.**

The permittee shall record on a daily basis the scrubber flows, scrubber temperatures, and scrubber absorbent media (KOH) conductivity. The recordings shall be maintained for 5 years and made available to the Department upon request.

**V. REPORTING REQUIREMENTS.**

No additional reporting requirements exist except as provided in other sections of this permit including Section B (State Only General Requirements).

**VI. WORK PRACTICE REQUIREMENTS.**

# 004 [25 Pa. Code §127.441]

**Operating permit terms and conditions.**

1. The aforementioned source(s) may only be operated as long as the associated air pollution control device(s) are operated and maintained in accordance with the specifications set forth in the respective plan approval(s), and the application(s) submitted for said plan approval(s) (as approved by the Department), and in accordance with any conditions set forth herein.

2. The company shall maintain and operates the air pollution control equipment and sources in accordance with good engineering practice.



**SECTION D. Source Level Requirements****VII. ADDITIONAL REQUIREMENTS.**

No additional requirements exist except as provided in other sections of this permit including Section B (State Only General Requirements).

**SECTION D. Source Level Requirements**

Source ID: 116

Source Name: NF3 WEST II PRODUCTION TRAINS 110 AND 120

Source Capacity/Throughput:

Conditions for this source occur in the following groups: GROUP 2

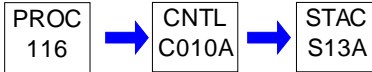
**I. RESTRICTIONS.**

No additional requirements exist except as provided in other sections of this permit including Section B (State Only General Requirements) and/or Section E (Source Group Restrictions).

**II. TESTING REQUIREMENTS.**

No additional testing requirements exist except as provided in other sections of this permit including Section B (State Only General Requirements) and/or Section E (Source Group Restrictions).

**III. MONITORING REQUIREMENTS.**

No additional monitoring requirements exist except as provided in other sections of this permit including Section B (State Only General Requirements) and/or Section E (Source Group Restrictions).

**IV. RECORDKEEPING REQUIREMENTS.**

No additional record keeping requirements exist except as provided in other sections of this permit including Section B (State Only General Requirements) and/or Section E (Source Group Restrictions).

**V. REPORTING REQUIREMENTS.**

No additional reporting requirements exist except as provided in other sections of this permit including Section B (State Only General Requirements) and/or Section E (Source Group Restrictions).

**VI. WORK PRACTICE REQUIREMENTS.**

No additional work practice requirements exist except as provided in other sections of this permit including Section B (State Only General Requirements) and/or Section E (Source Group Restrictions).

**VII. ADDITIONAL REQUIREMENTS.**

No additional requirements exist except as provided in other sections of this permit including Section B (State Only General Requirements) and/or Section E (Source Group Restrictions).

**SECTION D. Source Level Requirements**

Source ID: 117

Source Name: NF3 WEST II PRODUCTION TRAINS 130 AND 140

Source Capacity/Throughput:

Conditions for this source occur in the following groups: GROUP 2

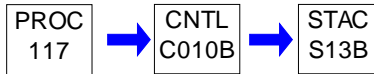
**I. RESTRICTIONS.**

No additional requirements exist except as provided in other sections of this permit including Section B (State Only General Requirements) and/or Section E (Source Group Restrictions).

**II. TESTING REQUIREMENTS.**

No additional testing requirements exist except as provided in other sections of this permit including Section B (State Only General Requirements) and/or Section E (Source Group Restrictions).

**III. MONITORING REQUIREMENTS.**

No additional monitoring requirements exist except as provided in other sections of this permit including Section B (State Only General Requirements) and/or Section E (Source Group Restrictions).

**IV. RECORDKEEPING REQUIREMENTS.**

No additional record keeping requirements exist except as provided in other sections of this permit including Section B (State Only General Requirements) and/or Section E (Source Group Restrictions).

**V. REPORTING REQUIREMENTS.**

No additional reporting requirements exist except as provided in other sections of this permit including Section B (State Only General Requirements) and/or Section E (Source Group Restrictions).

**VI. WORK PRACTICE REQUIREMENTS.**

No additional work practice requirements exist except as provided in other sections of this permit including Section B (State Only General Requirements) and/or Section E (Source Group Restrictions).

**VII. ADDITIONAL REQUIREMENTS.**

No additional requirements exist except as provided in other sections of this permit including Section B (State Only General Requirements) and/or Section E (Source Group Restrictions).

**SECTION D. Source Level Requirements**

Source ID: 118

Source Name: NF3 WEST II PRODUCTION TRAINS 150 AND 160

Source Capacity/Throughput:

Conditions for this source occur in the following groups: GROUP 2

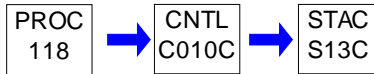
**I. RESTRICTIONS.**

No additional requirements exist except as provided in other sections of this permit including Section B (State Only General Requirements) and/or Section E (Source Group Restrictions).

**II. TESTING REQUIREMENTS.**

No additional testing requirements exist except as provided in other sections of this permit including Section B (State Only General Requirements) and/or Section E (Source Group Restrictions).

**III. MONITORING REQUIREMENTS.**

No additional monitoring requirements exist except as provided in other sections of this permit including Section B (State Only General Requirements) and/or Section E (Source Group Restrictions).

**IV. RECORDKEEPING REQUIREMENTS.**

No additional record keeping requirements exist except as provided in other sections of this permit including Section B (State Only General Requirements) and/or Section E (Source Group Restrictions).

**V. REPORTING REQUIREMENTS.**

No additional reporting requirements exist except as provided in other sections of this permit including Section B (State Only General Requirements) and/or Section E (Source Group Restrictions).

**VI. WORK PRACTICE REQUIREMENTS.**

No additional work practice requirements exist except as provided in other sections of this permit including Section B (State Only General Requirements) and/or Section E (Source Group Restrictions).

**VII. ADDITIONAL REQUIREMENTS.**

No additional requirements exist except as provided in other sections of this permit including Section B (State Only General Requirements) and/or Section E (Source Group Restrictions).

**SECTION D. Source Level Requirements**

Source ID: 119

Source Name: NF3 WEST II PRODUCTION TRAINS 170 AND 180

Source Capacity/Throughput:

Conditions for this source occur in the following groups: GROUP 2

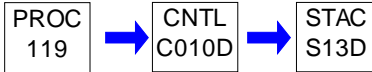
**I. RESTRICTIONS.**

No additional requirements exist except as provided in other sections of this permit including Section B (State Only General Requirements) and/or Section E (Source Group Restrictions).

**II. TESTING REQUIREMENTS.**

No additional testing requirements exist except as provided in other sections of this permit including Section B (State Only General Requirements) and/or Section E (Source Group Restrictions).

**III. MONITORING REQUIREMENTS.**

No additional monitoring requirements exist except as provided in other sections of this permit including Section B (State Only General Requirements) and/or Section E (Source Group Restrictions).

**IV. RECORDKEEPING REQUIREMENTS.**

No additional record keeping requirements exist except as provided in other sections of this permit including Section B (State Only General Requirements) and/or Section E (Source Group Restrictions).

**V. REPORTING REQUIREMENTS.**

No additional reporting requirements exist except as provided in other sections of this permit including Section B (State Only General Requirements) and/or Section E (Source Group Restrictions).

**VI. WORK PRACTICE REQUIREMENTS.**

No additional work practice requirements exist except as provided in other sections of this permit including Section B (State Only General Requirements) and/or Section E (Source Group Restrictions).

**VII. ADDITIONAL REQUIREMENTS.**

No additional requirements exist except as provided in other sections of this permit including Section B (State Only General Requirements) and/or Section E (Source Group Restrictions).

**SECTION D. Source Level Requirements**

Source ID: ENG1

Source Name: EMERGENCY FIRE PUMP ENGINE 1

Source Capacity/Throughput:

Conditions for this source occur in the following groups: GROUP 4

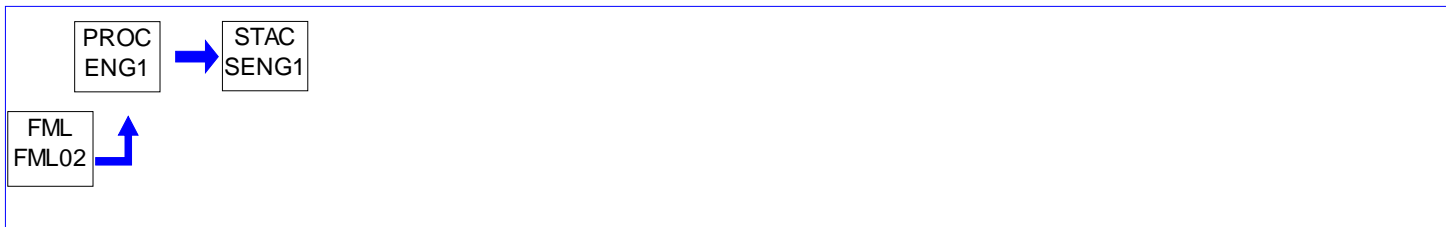
**I. RESTRICTIONS.**

No additional requirements exist except as provided in other sections of this permit including Section B (State Only General Requirements) and/or Section E (Source Group Restrictions).

**II. TESTING REQUIREMENTS.**

No additional testing requirements exist except as provided in other sections of this permit including Section B (State Only General Requirements) and/or Section E (Source Group Restrictions).

**III. MONITORING REQUIREMENTS.**

No additional monitoring requirements exist except as provided in other sections of this permit including Section B (State Only General Requirements) and/or Section E (Source Group Restrictions).

**IV. RECORDKEEPING REQUIREMENTS.**

No additional record keeping requirements exist except as provided in other sections of this permit including Section B (State Only General Requirements) and/or Section E (Source Group Restrictions).

**V. REPORTING REQUIREMENTS.**

No additional reporting requirements exist except as provided in other sections of this permit including Section B (State Only General Requirements) and/or Section E (Source Group Restrictions).

**VI. WORK PRACTICE REQUIREMENTS.**

No additional work practice requirements exist except as provided in other sections of this permit including Section B (State Only General Requirements) and/or Section E (Source Group Restrictions).

**VII. ADDITIONAL REQUIREMENTS.****# 001 [25 Pa. Code §127.441]****Operating permit terms and conditions.**

Source ID ENG1 is a 300 HP diesel-fired Detroit Model #PTA-1SD-50 emergency fire pump engine installed in 1973.

**SECTION D. Source Level Requirements**

Source ID: ENG2

Source Name: EMERGENCY GENERATOR 1

Source Capacity/Throughput:

Conditions for this source occur in the following groups: GROUP 4

**I. RESTRICTIONS.**

No additional requirements exist except as provided in other sections of this permit including Section B (State Only General Requirements) and/or Section E (Source Group Restrictions).

**II. TESTING REQUIREMENTS.**

No additional testing requirements exist except as provided in other sections of this permit including Section B (State Only General Requirements) and/or Section E (Source Group Restrictions).

**III. MONITORING REQUIREMENTS.**

No additional monitoring requirements exist except as provided in other sections of this permit including Section B (State Only General Requirements) and/or Section E (Source Group Restrictions).

**IV. RECORDKEEPING REQUIREMENTS.**

No additional record keeping requirements exist except as provided in other sections of this permit including Section B (State Only General Requirements) and/or Section E (Source Group Restrictions).

**V. REPORTING REQUIREMENTS.**

No additional reporting requirements exist except as provided in other sections of this permit including Section B (State Only General Requirements) and/or Section E (Source Group Restrictions).

**VI. WORK PRACTICE REQUIREMENTS.**

No additional work practice requirements exist except as provided in other sections of this permit including Section B (State Only General Requirements) and/or Section E (Source Group Restrictions).

**VII. ADDITIONAL REQUIREMENTS.****# 001 [25 Pa. Code §127.441]****Operating permit terms and conditions.**

Source ID ENG2 is a 475 HP diesel-fired Caterpillar Model #3406C emergency generator installed in June 1995.

**SECTION D. Source Level Requirements**

Source ID: ENG3

Source Name: EMERGENCY GENERATOR 2

Source Capacity/Throughput:

Conditions for this source occur in the following groups: GROUP 4

**I. RESTRICTIONS.**

No additional requirements exist except as provided in other sections of this permit including Section B (State Only General Requirements) and/or Section E (Source Group Restrictions).

**II. TESTING REQUIREMENTS.**

No additional testing requirements exist except as provided in other sections of this permit including Section B (State Only General Requirements) and/or Section E (Source Group Restrictions).

**III. MONITORING REQUIREMENTS.**

No additional monitoring requirements exist except as provided in other sections of this permit including Section B (State Only General Requirements) and/or Section E (Source Group Restrictions).

**IV. RECORDKEEPING REQUIREMENTS.**

No additional record keeping requirements exist except as provided in other sections of this permit including Section B (State Only General Requirements) and/or Section E (Source Group Restrictions).

**V. REPORTING REQUIREMENTS.**

No additional reporting requirements exist except as provided in other sections of this permit including Section B (State Only General Requirements) and/or Section E (Source Group Restrictions).

**VI. WORK PRACTICE REQUIREMENTS.**

No additional work practice requirements exist except as provided in other sections of this permit including Section B (State Only General Requirements) and/or Section E (Source Group Restrictions).

**VII. ADDITIONAL REQUIREMENTS.****# 001 [25 Pa. Code §127.441]****Operating permit terms and conditions.**

Source ID ENG3 is a 474 HP diesel-fired Detroit Model #S60 emergency generator installed in October 2006.



**SECTION D. Source Level Requirements**

Source ID: ENG4

Source Name: EMERGENCY GENERATOR 3

Source Capacity/Throughput:

Conditions for this source occur in the following groups: GROUP 4

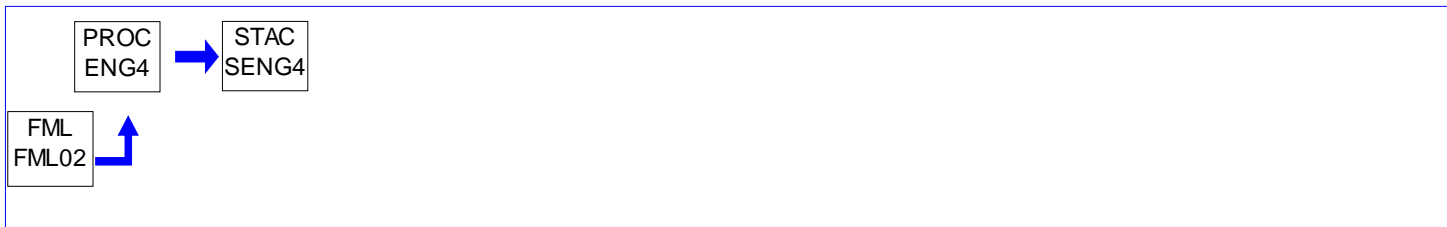
**I. RESTRICTIONS.**

No additional requirements exist except as provided in other sections of this permit including Section B (State Only General Requirements) and/or Section E (Source Group Restrictions).

**II. TESTING REQUIREMENTS.**

No additional testing requirements exist except as provided in other sections of this permit including Section B (State Only General Requirements) and/or Section E (Source Group Restrictions).

**III. MONITORING REQUIREMENTS.**

No additional monitoring requirements exist except as provided in other sections of this permit including Section B (State Only General Requirements) and/or Section E (Source Group Restrictions).

**IV. RECORDKEEPING REQUIREMENTS.**

No additional record keeping requirements exist except as provided in other sections of this permit including Section B (State Only General Requirements) and/or Section E (Source Group Restrictions).

**V. REPORTING REQUIREMENTS.**

No additional reporting requirements exist except as provided in other sections of this permit including Section B (State Only General Requirements) and/or Section E (Source Group Restrictions).

**VI. WORK PRACTICE REQUIREMENTS.**

No additional work practice requirements exist except as provided in other sections of this permit including Section B (State Only General Requirements) and/or Section E (Source Group Restrictions).

**VII. ADDITIONAL REQUIREMENTS.**

# 001 [25 Pa. Code §127.441]

**Operating permit terms and conditions.**

Source ID ENG4 is a 118 HP diesel-fired Cummins Model #QSB-4.5 emergency generator installed in May 2008.

**SECTION E. Source Group Restrictions.**

Group Name: GROUP 1

Group Description: Controlled Processes

Sources included in this group

ID	Name
103	FLUORINE CHEM OPERATIONS
105	RESIDUAL GAS TREATMENT OPERATION
106B	TOUCH-UP PAINT BOOTHS
107	F2 COLD DEGREASER
111	NF3 WEST OPERATIONS

**I. RESTRICTIONS.****Emission Restriction(s).**

# 001 [25 Pa. Code §123.13]

**Processes**

No person may permit the emission into the outdoor atmosphere of particulate matter in a manner that the concentration of particulate matter in the effluent gas exceeds 0.04 grain per dry standard cubic foot, when the effluent gas volume is less than 150,000 dry standard cubic feet per minute.

**II. TESTING REQUIREMENTS.**

No additional testing requirements exist except as provided in other sections of this permit including Section B (State Only General Requirements).

**III. MONITORING REQUIREMENTS.**

No additional monitoring requirements exist except as provided in other sections of this permit including Section B (State Only General Requirements).

**IV. RECORDKEEPING REQUIREMENTS.**

No additional record keeping requirements exist except as provided in other sections of this permit including Section B (State Only General Requirements).

**V. REPORTING REQUIREMENTS.**

No additional reporting requirements exist except as provided in other sections of this permit including Section B (State Only General Requirements).

**VI. WORK PRACTICE REQUIREMENTS.**

# 002 [25 Pa. Code §127.444]

**Compliance requirements.**

At all times that these sources are in operation, the associated air pollution control devices shall also be in operation and operated in accordance with the manufacturer's specifications.

**VII. ADDITIONAL REQUIREMENTS.**

No additional requirements exist except as provided in other sections of this permit including Section B (State Only General Requirements).

**SECTION E. Source Group Restrictions.**

Group Name: GROUP 2

Group Description: Nitrogen Trifluoride West II Plant

Sources included in this group

ID	Name
116	NF3 WEST II PRODUCTION TRAINS 110 AND 120
117	NF3 WEST II PRODUCTION TRAINS 130 AND 140
118	NF3 WEST II PRODUCTION TRAINS 150 AND 160
119	NF3 WEST II PRODUCTION TRAINS 170 AND 180
C010ANF3	WEST II SCRUBBER 810
C010BNF3	WEST II SCRUBBER 820
C010CNF3	WEST II SCRUBBER 830
C010DNF3	WEST II SCRUBBER 840

**I. RESTRICTIONS.****Emission Restriction(s).****# 001 [25 Pa. Code §127.441]****Operating permit terms and conditions.**

The sources in this source group are subject to the following air contaminant emission limitations:

## Pollutant Atmospheric Emissions

	Lb/hr	Tons per year
NF3	147	16.6
HF	0.3	0.02
CF4	0.02	0.002
N2F2	0.99	0.10
N2O	0.22	0.07
NH3	0.46	0.05
OF2	0.31	0.03

**II. TESTING REQUIREMENTS.****# 002 [25 Pa. Code §127.441]****Operating permit terms and conditions.**

If at any time the Department has cause to believe that air contaminant emissions from the aforementioned source(s) may be in excess of the limitations specified in, or established pursuant to, any applicable rule or regulation contained in Article III of the Rules and Regulations of the Department of Environmental Protection, the company shall be required to conduct whatever tests are deemed necessary by the Department to determine the actual emission rate(s). Such testing shall be conducted in accordance with the revisions of Chapter 139 of the Rules and Regulations Environmental Protection, where applicable, and in accordance with any restrictions or limitations established by the Department at such time as it notifies the company that testing is required.

**III. MONITORING REQUIREMENTS.****# 003 [25 Pa. Code §127.441]****Operating permit terms and conditions.**

1. The company shall monitor the scrubber flows and temperatures daily. The company shall continuously monitor the scrubber absorbent media (KOH) conductivity. Alarms shall be installed that signal plant personnel when there is a reduction in the flow rate through the scrubber, differential pressure, and maximum temperature. At no time shall the scrubber be operated when there is a reduction of flow below acceptable levels.
2. The company shall ensure that the control devices shall be equipped with the applicable monitoring equipment and the monitoring equipment shall be installed, calibrated, operated, and maintained according to the vendor's specifications at all times the control device is in use.

**SECTION E. Source Group Restrictions.****IV. RECORDKEEPING REQUIREMENTS.****# 004 [25 Pa. Code §127.441]****Operating permit terms and conditions.**

The permittee shall record the scrubber flows, scrubber temperatures, and scrubber absorbent media (KOH) conductivity. The recordings shall be maintained and made available to the Department upon request.

**V. REPORTING REQUIREMENTS.**

No additional reporting requirements exist except as provided in other sections of this permit including Section B (State Only General Requirements).

**VI. WORK PRACTICE REQUIREMENTS.****# 005 [25 Pa. Code §127.441]****Operating permit terms and conditions.**

1. The aforementioned source(s) may only be operated as long as the associated air pollution control device(s) are operated and maintained in accordance with any conditions set forth herein.
2. The company shall maintain and operates the air pollution control equipment and sources in accordance with good engineering practice.

**VII. ADDITIONAL REQUIREMENTS.****# 006 [25 Pa. Code §127.441]****Operating permit terms and conditions.**

The company shall not impose conditions upon or otherwise restrict the Department's access to the aforementioned source(s) and/or any associated air cleaning device(s) and shall allow the Department to have access at any time to said source(s) and associated air cleaning device(s) with such measuring and recording equipment, including equipment recording visual observations, as the Department deems necessary and proper for performing its duties and for the effective enforcement of the Air Pollution Control Act.

**SECTION E. Source Group Restrictions.**

Group Name: GROUP 3

Group Description: Boilers

Sources included in this group

ID	Name
031	WEST 2 BOILER 1
032	WEST 2 BOILER 2

**I. RESTRICTIONS.****Emission Restriction(s).****# 001 [25 Pa. Code §123.11]****Combustion units**

A person may not permit the emission into the outdoor atmosphere of particulate matter from a combustion unit in excess of the rate of 0.4 pound per million Btu of heat input, when the heat input to the combustion unit in millions of Btus per hour is greater than 2.5 but less than 50.

**# 002 [25 Pa. Code §123.22]****Combustion units**

No person may permit the emission into the outdoor atmosphere of sulfur oxides, expressed as SO<sub>2</sub>, from a combustion unit in excess of the rate of 4 pounds per million Btu of heat input over any 1-hour period.

**# 003 [25 Pa. Code §127.12b]****Plan approval terms and conditions.**

BAT for units with a rated capacity equal to or greater than 10 million BTU/hr shall include the installation of low NO<sub>x</sub> burners, flue gas recirculation (FGR), combinations of these, or other measures capable of meeting the following emission limitations:

- (1) 90 ppm<sub>d</sub> NO<sub>x</sub> at 3% O<sub>2</sub>.
- (2) 400 ppm<sub>d</sub> CO at 3% O<sub>2</sub>.

**Fuel Restriction(s).****# 004 [25 Pa. Code §127.441]****Operating permit terms and conditions.**

- 1) These boilers shall be fired by #2 fuel oil only.
- 2) The sulfur content of the #2 fuel oil shall not exceed 0.05% (500 ppm), by weight.

**II. TESTING REQUIREMENTS.****# 005 [25 Pa. Code §127.441]****Operating permit terms and conditions.**

The permittee shall, upon the request of the Department, provide fuel analyses, or fuel samples of the #2 fuel oil used in these boilers.

**# 006 [25 Pa. Code §139.11]****General requirements.**

If, at any time, the Department has cause to believe that air contaminant emissions from a combustion unit are in excess of the limitations specified in, or established pursuant to, any applicable regulation contained in 25 Pa. Code, Subpart C, Article III, the permittee shall conduct tests deemed necessary by the Department to determine the actual emission rate(s).

**III. MONITORING REQUIREMENTS.****# 007 [25 Pa. Code §127.441]****Operating permit terms and conditions.**

The permittee shall install and maintain the necessary meter(s) to determine and to record amount of fuel usage.

**SECTION E. Source Group Restrictions.****IV. RECORDKEEPING REQUIREMENTS.****# 008 [40 CFR Part 60 Standards of Performance for New Stationary Sources §40 CFR 60.48c]  
Subpart Dc - Standards of Performance for Small Industrial- Commercial-Institutional Steam Generating Units  
Reporting and recordkeeping requirements.**

The permittee shall record and maintain daily fuel consumption records in accordance with 40 CFR 60.48c(g). Records shall be kept for the fuel firing rates of the combustion units on a monthly basis in order to determine sulfur dioxide (SO<sub>2</sub>) emissions in accordance with 40 CFR §60.48c(d).

**V. REPORTING REQUIREMENTS.****# 009 [40 CFR Part 60 Standards of Performance for New Stationary Sources §40 CFR 60.40c]  
Subpart Dc - Standards of Performance for Small Industrial- Commercial-Institutional Steam Generating Units  
Applicability and delegation of authority.**

Pursuant to 40 CFR §60.4, the permittee shall submit copies of all requests, reports, applications, submittals, and other communications to both EPA and the appropriate Regional Office of the Department.

The EPA copies shall be forwarded to:

Air Enforcement Branch, Mail Code 3AP12  
US EPA, Region III  
1650 Arch Street  
Philadelphia PA 19103-2029

**# 010 [40 CFR Part 60 Standards of Performance for New Stationary Sources §40 CFR 60.48c]  
Subpart Dc - Standards of Performance for Small Industrial- Commercial-Institutional Steam Generating Units  
Reporting and recordkeeping requirements.**

The permittee shall comply with the recordkeeping and certification requirements in accordance with 40 CFR 60.46c(e), 60.42c(h) and 60.48c(f)(1). Reports shall be submitted on a semi-annual basis unless no excess emissions occurred. If there are no excess emissions, the permittee shall semi-annually report that no excess emissions occurred during the semi-annual reporting period.

**# 011 [40 CFR Part 60 Standards of Performance for New Stationary Sources §40 CFR 60.48c]  
Subpart Dc - Standards of Performance for Small Industrial- Commercial-Institutional Steam Generating Units  
Reporting and recordkeeping requirements.**

Semi-annual reports shall be submitted by the permittee in accordance with 40 CFR §§60.48c(d), 60.48c(e)(11) and 60.48c(j). The initial semi-annual report shall be postmarked by the 30th day of the sixth month following the completion of the initial performance test. Each subsequent report shall be postmarked by the 30th day following the end of the reporting period.

**VI. WORK PRACTICE REQUIREMENTS.****# 012 [25 Pa. Code §127.441]  
Operating permit terms and conditions.**

The boilers shall be:

- (1) Operated in such a manner as not to cause air pollution.
- (2) Operated and maintained in a manner consistent with good operating and maintenance practices.
- (3) Operated and maintained in accordance with manufacturer's specifications.

**VII. ADDITIONAL REQUIREMENTS.****# 013 [25 Pa. Code §127.441]  
Operating permit terms and conditions.**

Source 031 and 032 are subject to 40 CFR 63, Subpart JJJJJJ, National Emission Standards for Hazardous Air Pollutants for Industrial, Commercial, and Institutional Boilers Area Sources.

**SECTION E. Source Group Restrictions.**

Group Name: GROUP 4

Group Description: Emergency Engines

Sources included in this group

ID	Name
ENG1	EMERGENCY FIRE PUMP ENGINE 1
ENG2	EMERGENCY GENERATOR 1
ENG3	EMERGENCY GENERATOR 2
ENG4	EMERGENCY GENERATOR 3

**I. RESTRICTIONS.****Emission Restriction(s).**

# 001 [25 Pa. Code §127.441]

**Operating permit terms and conditions.**

Combined NOx emissions for all exempt engines at the site shall be less than 100 lbs/hr, 1000 lbs/day, 2.75 tons per ozone season and 6.6 tons per year on a 12-month rolling sum basis.

**II. TESTING REQUIREMENTS.**

No additional testing requirements exist except as provided in other sections of this permit including Section B (State Only General Requirements).

**III. MONITORING REQUIREMENTS.**

No additional monitoring requirements exist except as provided in other sections of this permit including Section B (State Only General Requirements).

**IV. RECORDKEEPING REQUIREMENTS.**

# 002 [25 Pa. Code §127.441]

**Operating permit terms and conditions.**

The company shall keep adequate records to show compliance with the emission limitations.

# 003 [25 Pa. Code §127.441]

**Operating permit terms and conditions.**

The owner or operator of the emergency generators shall maintain an operating log of any days that the engines are operated. The operating log shall include the dates each unit operated, the total operating hours per day during each operating date, and the total number of days and hours of operation per each 12-month rolling sum period.

# 004 [25 Pa. Code §127.441]

**Operating permit terms and conditions.**

These records shall be maintained and kept on site for the most recent 5-year period and made available to the Department upon request.

**V. REPORTING REQUIREMENTS.**

No additional reporting requirements exist except as provided in other sections of this permit including Section B (State Only General Requirements).

**VI. WORK PRACTICE REQUIREMENTS.**

# 005 [25 Pa. Code §127.441]

**Operating permit terms and conditions.**

The emergency generators shall be equipped with a non-resettable hour meters prior to startup of the engines and the meters shall be operated at all times the sources are in operation.

**VII. ADDITIONAL REQUIREMENTS.**

# 006 [25 Pa. Code §127.441]

**Operating permit terms and conditions.**

**SECTION E. Source Group Restrictions.**

Source ID ENG1 and Source ID ENG2 are subject to NESHAP 40 CFR Part 63 Subpart ZZZZ and shall comply with all applicable requirements as specified in 40 CFR Sections 63.6580 through 63.6675.

**# 007 [25 Pa. Code §127.441]****Operating permit terms and conditions.**

Source ID ENG3 and Source ID ENG4 are subject to NSPS 40 CFR Part 60 Subpart IIII and shall comply with all applicable requirements as specified in 40 CFR Sections 60.4200 through 60.4219.





**SECTION F. Alternative Operation Requirements.**

No Alternative Operations exist for this State Only facility.



**SECTION G. Emission Restriction Summary.**

No emission restrictions listed in this section of the permit.

**SECTION H. Miscellaneous.**

(a) The Department received the operating application for this facility on 6/12/2019. The annual operating permit administrative fee per 25 Pa. Code, Chapter 127, Section 127.703(c)(3) for this permit shall be \$375.00. The fee is due 30 days prior to the anniversary date of the issuance of the permit.

(b) This is a Synthetic Minor operating permit.

(c) This permit incorporates the requirements from the following plan approvals:

54-313-073D  
54-313-083  
54-313-084  
54-313-085  
54-313-088  
54-302-070GP  
54-302-071GP

(d) Requests for Determination include:

54-0395; 54-0399; 54-0400; 54-0402; 54-0404; 54-0409; 54-0410; 54-0415; 54-0420; 54-0435a; 54-0438; 54-0439; 54-0441; 54-0443; 54-0446; 54-0447; 54-0451; 54-0454; 54-0463; 54-0464; 54-0472; 54-0476; 54-0491; 54-0494; 54-0509; 54-0536; 54-0537; 54-0541[**DENIED**]; 54-0557; 54-0558; 54-0559; 54-0573; 54-0575; 54-0580; 54-0587; 54-0588; 54-0594; 54-0595; 54-0596; 54-0597; 54-0600; 54-0603; 54-0611; 54-0617; 54-0622

(e) The following is a list of sources that have been determined by the Department to be of minor significance under 25 Pa. Code, Chapter 127, Section 127.14(a)(8) and are not regulated in this State-Only Operating Permit:

(a) Main Fill Bldg. Boiler, a Superior Model #6973-12291 combustion unit installed in 1972 and fired by #2 fuel oil with a rated heat input of 6.7 MMBtu/hr.

(b) R&D Bldg. Boiler, a Superior Model #6972-12290 combustion unit installed in 1972 and fired by #2 fuel oil with a rated heat input of 1.7 MMBtu/hr.

(c) Maintenance Bldg. Boiler, a Cleaver-Brooks Model #M4W-2000 combustion unit installed in 1980 and fired by #2 fuel oil with a rated heat input of 1.6 MMBtu/hr.

(d) CF4 Bldg. Boiler, a Weil McLain Co., Inc. Model #998 combustion unit installed in 1982 and fired by #2 fuel oil with a rated heat input of 2.2 MMBtu/hr.

(e) Cylinder Maintenance Heaters (HV-1 & HV-2), two (2) Jackson & Church space heaters installed in 1988 and fired by #2 fuel oil with a rated heat input of 1.5 MMBtu/hr each.

(f) Organometallics Bldg. Boiler, a Weil McLain Model #3 combustion unit installed in 1989 and fired by #2 fuel oil with a rated heat input of 4.07 MMBtu/hr.

(g) ECPA/Engineering Bldg. Boiler, a Weil McLain Model #988 combustion unit installed in 1980 and fired by #2 fuel oil with a rated heat input of 1.02 MMBtu/hr.

(h) Administration Bldg. Boiler, a Weil McLaine Model #2 combustion unit installed in 1972 and fired by #2 fuel oil with a rated heat input of 0.73 MMBtu/hr.

(i) TBA/TBP Emergency Generator, a Caterpillar Model #3406 generator installed in 1995 and fired by diesel fuel.

(j) Pump House Generator, a Detroit Diesel Model #PTA-150-50 generator installed in 1973 and fired by diesel fuel.

(k) Maintenance Shop Vapor Degreaser, a Branson Model #B400 degreaser installed in 1991.

(l) Maintenance Shop Cold Degreaser, a Safety-Kleen Model #105 degreaser.

(m) Various facility ventilation ducts, hoods and vents.

(n) ECPA Operation Paint Booths installed in 1994.

(o) ELF Operation Scrubber installed in 1992.

(p) F-TEDA Scrubber installed in 1993 for use in the R&D operation.

(q) NF3 Scrubber installed in 1977 for use in the old NF3 plant.

(r) R&D NF3 Reactor Scrubber installed in 1995 for use in R&D operations.

(s) All ERC operations.

(t) CF4 Production Plant installed in 1983, modified in 1996 & 2000.

(u) EPA Protocol Blend Manifold Vent installed in 1993.

(v) EPA Protocol Gas Blend Residual V.ent installed in 1993.

(w) ECPA Paint Booth installed in 1994.

(x) ELF HCl Scrubber installed in 1992.

(y) F-teda Scrubber installed in 1993.

(z) NF3 South Production Plant installed in 1977.

**SECTION H. Miscellaneous.**

- (aa) Cylinder Degreasing System installed in 1996.
- (bb) HCl Acid Waste Tanks installed in 1995.
- (cc) HCl Cylinder Fill installed in 1995.
- (dd) ECPA Residual Product Venting installed in 1994.
- (ee) Gas Mixture Operations installed in 1993.
- (ff) SF6 Distillation Column Vents installed in 1974.
- (gg) WF6 Purification Plant installed in 1998.
- (hh) EPA Protocol Blending Manifolds installed in 1997.
- (ii) HCl Y Cylinder Fill installed in 1995.
- (jj) HCl Dump Station installed in 1995.
- (kk) HCl Tube Trailer Fill installed in 1995.
- (ll) Liquefied Halocarbon Gas Fill Operation installed in 1997.
- (mm) ELF Paint Booth installed in 1998.
- (nn) Fluorine East Cold Degreaser installed in 1999.
- (oo) Contractor Cold Degreaser installed in 1999.
- (pp) Sandblasting Area installed in 1996.
- (qq) Dichlorosilane Transfill Operation installed in 1998.
- (rr) R&D Activities installed in 1995.
- (ss) R&D Activities-New Process Development Building installed in 1999, modified in 2000.
- (tt) Hexafluoroethane Transfill Operation installed in 1997.
- (uu) Liquid Fill Operations installed in 2000.
- (w) Hydrogen Chloride Purifier Regeneration Process installed in 1999.
- (ww) Tungsten Hexafluoride Production Plant installed in 1997.
- (xx) GAN Plant installed in 2000.
- (yy) Cylinder Maintenance Shotblaster installed in 2000.
- (zz) Cell Repair East Scrubber installed in 2000.
- (aaa) Hexafluoro-1,3-butadiene (C4F6) installed in 2000.
- (bbb) HF Building installed in 2001.
- (ccc) R&D NF3 Pilot Reactor installed in 2001.
- (ddd) Fluorine West Cold Degreaser installed in 2001.
- (eee) Main Fill Laser Mix Vent installed in 2001.
- (fff) WF6 Expansion installed in 2002.
- (ggg) Ammonia Purification installed in 2002.
- (hhh) Standards Lab Oxidant Blending Booth installed in 2002.
- (iii) Venting of NF3 Tube Trailers with 10% Airopak installed in 2002.
- (jjj) Installation of Eductors on F2 East H2 Scrubbers installed in 2002.
- (kkk) HF cylinder fill station installed in 2009.
- (lll) Monochlorosilane synthesis and purification process installed in 2000.
- (mmm) Nitric Oxide (NO) cylinder analyzation process installed in 2009.
- (nnn) BTBAS R&D production process installed in 2009.
- (ooo) R&D Lab AHF Test Scrubber installed in 2009.
- (ppp) Silane tube trailer passivation installed in 2010.
- (qqq) R&D XeF2 scrubber installed in 2009.
- (rrr) C2F6 venting for container prep installed in 1997.
- (sss) SF6 venting from tanks installed in 2010.
- (ttt) Additional WF6 expansion installed in 1997
- (uuu) Monochlorosilane synthesis expansion installed in 2001.
- (vvv) Trisilyamine (TSA) process installed in 2011.
- (xxx) Second anhydrous ammonia plant installed in 2011.
- (yyy) Nitric Oxide (N2O) manifold venting installed in 2012.
- (zzz) TSA vacuum conveyor discharge installed in 2012.
- (aaaa) Second R&D XeF2 plant installed in 2012.
- (bbbb) Cb Cobalt process development unit installed in 2013.
- (cccc) Cobalt container washing installed in 2014.
- (dddd) Ammonium bi-flouride (ABF) tote transfill installed in 2015.
- (eeee) Germane process increase installed in 2017.
- (ffff) Additional WF6 expansion installed in 2018.
- (gggg) Second ammonia distillation column installed in 2018.
- (hhhh) High purity flourine to Airopak installed in 2018.

**SECTION H. Miscellaneous.**

- (iii) CCTBA R&D process development unit installed in 2019.
- (jjj) DSBA reactor process installed in 2019.



\*\*\*\*\* End of Report \*\*\*\*\*

---